



Precision and perfection for pragmatic results

KPRO was established in 2015. KPRO is professional in researching, developing, producing and integrating different verticles of sliding rollers.

KPRO cohere to the concept of professional development. In past have specialised extensively in hardware values, and robust, comprehensive solutions encompassing the hardware sector. **KPRO** takes products innovation as the essential part in development. KPRO is working with good reputation, high quality products with scientific technology to ensure the stable quality and optimize the products. KPRO examine, perceive and delivers the products that leverages the customers.



INDEX

TOPICS	PAGE
Bed Fittings System :	03 - 23
Motorised Bed Fitting / Normal Bed Fitting / Bed Frame with Bed Fitting / Tip Up Fitting / Wall Mounting Bed Metal / Wall Mounting Wood Frame (Motorised & Normal) / Wall Mounting Sofa Cum Bed (Motorised & Normal) / Wall Mounting Horizontal Bed (Motorised & Normal) / Wall Mounting Dining Table Cum Bed (Motorised & Normal) / Wall Mounting Writing Table Cum Bed (Motorised & Normal) / Wall Mounting Bunk Bed / Wall Mounting Bed Side Legs	
Motorised TV System	23
Compact Fittings :	24 - 31
Dining Folding System / Shoes Sitting Table / Concealed Table / Sofa Cum Bed Fitting / Centre Table to Dining Folding System / Centre Table System	

MOTORISED BED FITTINGS

KPRO®

(WIRELESS REMOTE OPERATED)

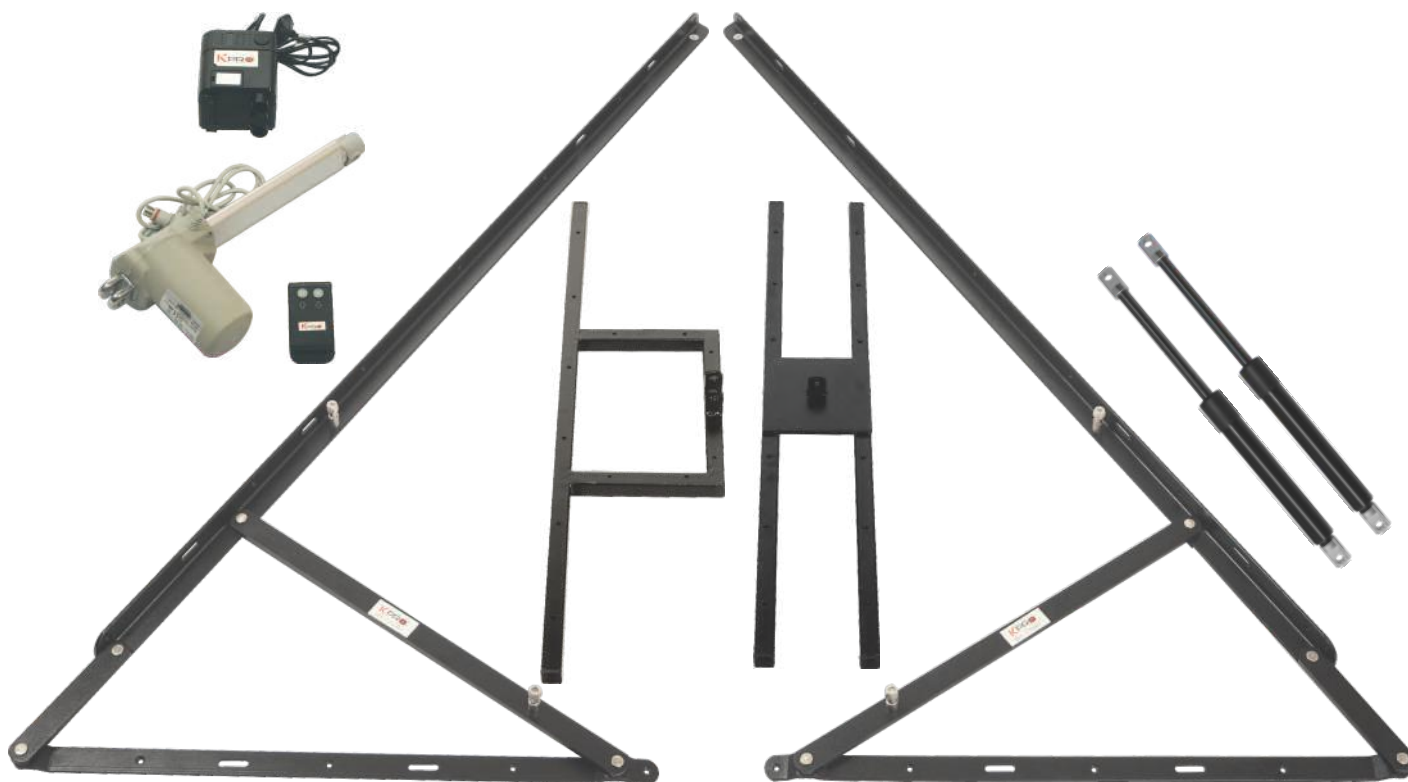

Code : 9001
Material : Mild Steel
Set Contains : 5' long supporting frame, top frame,
backend frame, motor, control box, remote & fastners
Finish : Black (Sand Blast)
Load Capacity : 0kg to 300kg

Note : Bed size required Min. Width 3' 6"
Max. Length 7'

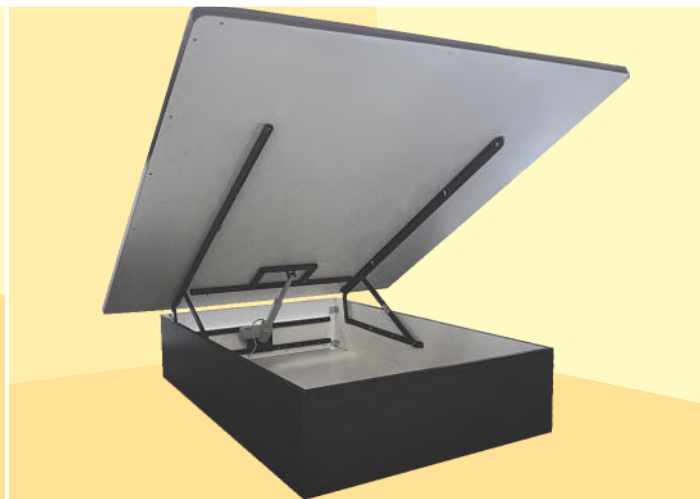
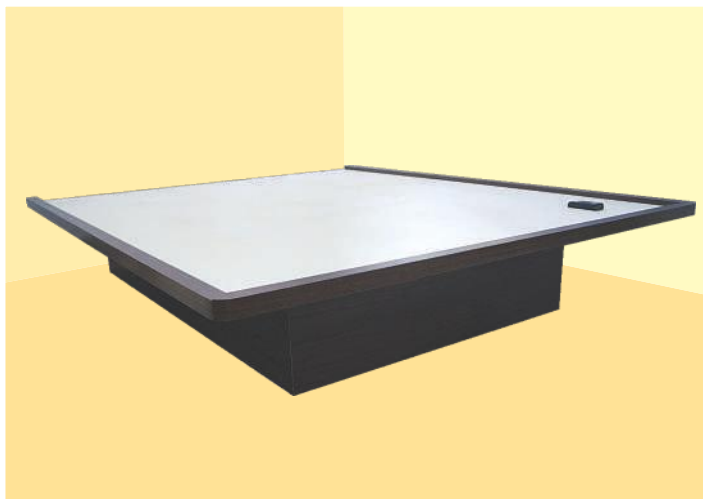

(PLATINIUM) (5mm Frame)

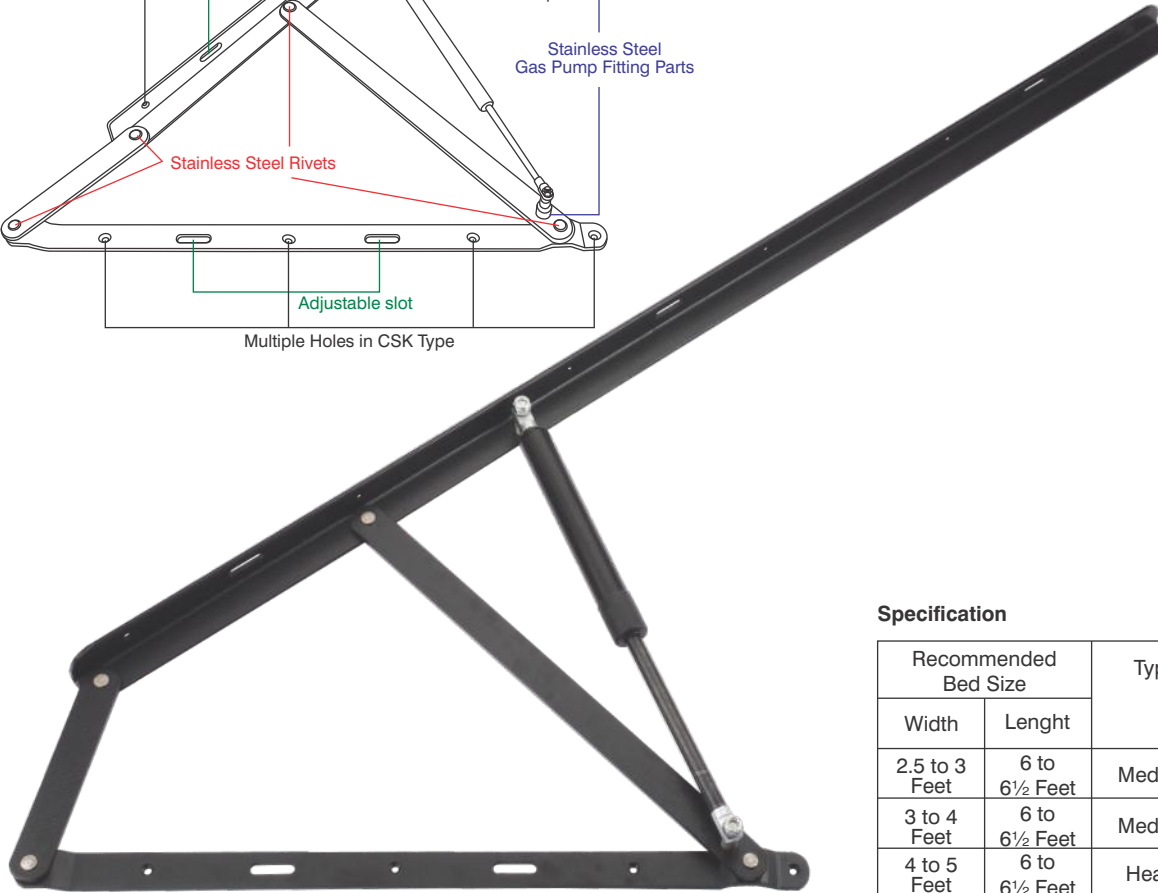
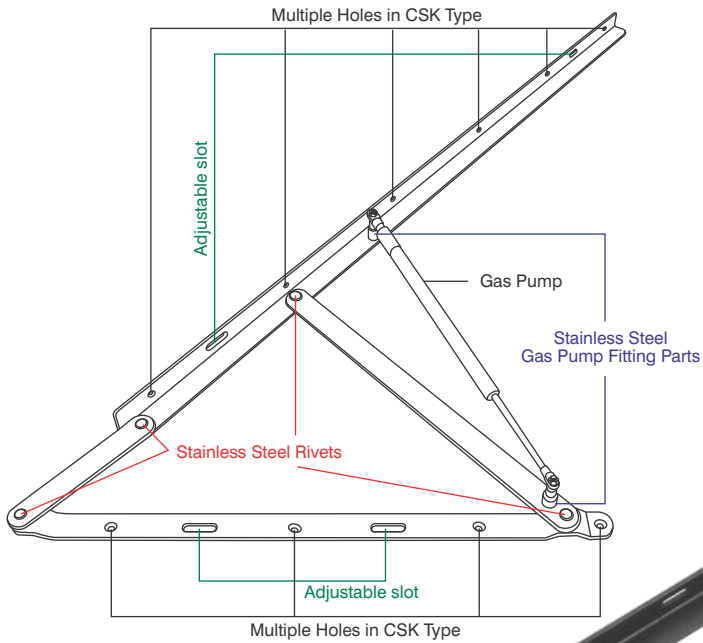

- ◀ Base (Mild Steel Material).
- ◀ All other parts in Stainless Steel.
- ◀ Sand Blasted Black Powder Coated Finish.
- ◀ Heavy Duty Gas Spring.
- ◀ 5mm Thickness

Specification

Recommended Bed Size		Type	Max Weight (Kgs.)
Width	Lenght		
2.5 to 3 Feet	6 to 6½ Feet	Medium	50 Kg.
3 to 4 Feet	6 to 6½ Feet	Medium	75 Kg. / 100 Kg.
4 to 5 Feet	6 to 6½ Feet	Heavy	100 Kg. / 125 Kg.
5 to 6 Feet	6 to 6½ Feet	Heavy	150 Kg. / 175 Kg.
6 to 7 Feet	6 to 6½ Feet	Extra Heavy	200 Kg.

Note : Approximate Chart.
Depends on bed matteress weight and ply weight

CODE	DESCRIPTION	SIZE	FINISH	REMARKS	BOX PACK
9002	BED FITTING FRAME with Gas Pump	2 FEET	Sand Blasted Black Powder Coated Finish	1 SET PKG.	6 Set
9003	BED FITTING FRAME with Gas Pump	3 FEET	Sand Blasted Black Powder Coated Finish	1 SET PKG.	6 Set
9004	BED FITTING FRAME with Gas Pump	4 FEET	Sand Blasted Black Powder Coated Finish	1 SET PKG.	4 Set
9005	BED FITTING FRAME with Gas Pump	5 FEET	Sand Blasted Black Powder Coated Finish	1 SET PKG.	2 Set
9006	BED FITTING FRAME with Gas Pump	6 FEET	Sand Blasted Black Powder Coated Finish	1 SET PKG.	2 Set
9007	GAS SPRING (50KG, 75KG, 100KG, 125KG, 150KG, 175KG, 200KG)	17 INCH	Black Powder Coated Finish	1 PAIR PKG.	36 Set

HEAVY BED FITTINGS



(ECONOMIC) (5mm Frame)



CODE	DESCRIPTION	SIZE	FINISH	REMARKS	BOX PACK
9008	BED FITTING FRAME with Gas Spring	2 FEET	7 Time Process Black Powder Coated Finish	1 SET PKG.	6 SETS
9009	BED FITTING FRAME with Gas Spring	3 FEET	7 Time Process Black Powder Coated Finish	1 SET PKG.	6 SETS
9010	BED FITTING FRAME with Gas Spring	4 FEET	7 Time Process Black Powder Coated Finish	1 SET PKG.	4 SETS
9011	BED FITTING FRAME with Gas Spring	5 FEET	7 Time Process Black Powder Coated Finish	1 SET PKG.	4 SETS
9007	GAS SPRING (50KG., 75KG., 100KG., 125KG., 150KG., 175KG., 200KG.)	17 INCH	Black Powder Coated Finish	1 SET PKG.	30 SETS

(3mm FRAME)



CODE	DESCRIPTION	SIZE	FINISH	REMARKS	BOX PACK
9012	BED FITTING FRAME with Gas Spring	2 FEET	7 Time Process Black Powder Coated Finish	1 SET PKG.	10 SETS
9013	BED FITTING FRAME with Gas Spring	3 FEET	7 Time Process Black Powder Coated Finish	1 SET PKG.	6 SETS
9014	BED FITTING FRAME with Gas Spring	4 FEET	7 Time Process Black Powder Coated Finish	1 SET PKG.	6 SETS
9015	BED FITTING FRAME with Gas Spring	5 FEET	7 Time Process Black Powder Coated Finish	1 SET PKG.	4 SETS
9016	GAS SPRING (50KG., 75KG., 100KG., 125KG., 150KG.)	14 INCH	Black Powder Coated Finish	1 SET PKG.	35 SETS

BED TOP FRAME WITH MOTORISED BED FITTINGS

KPRO®

(WIRELESS REMOTE OPERATED)

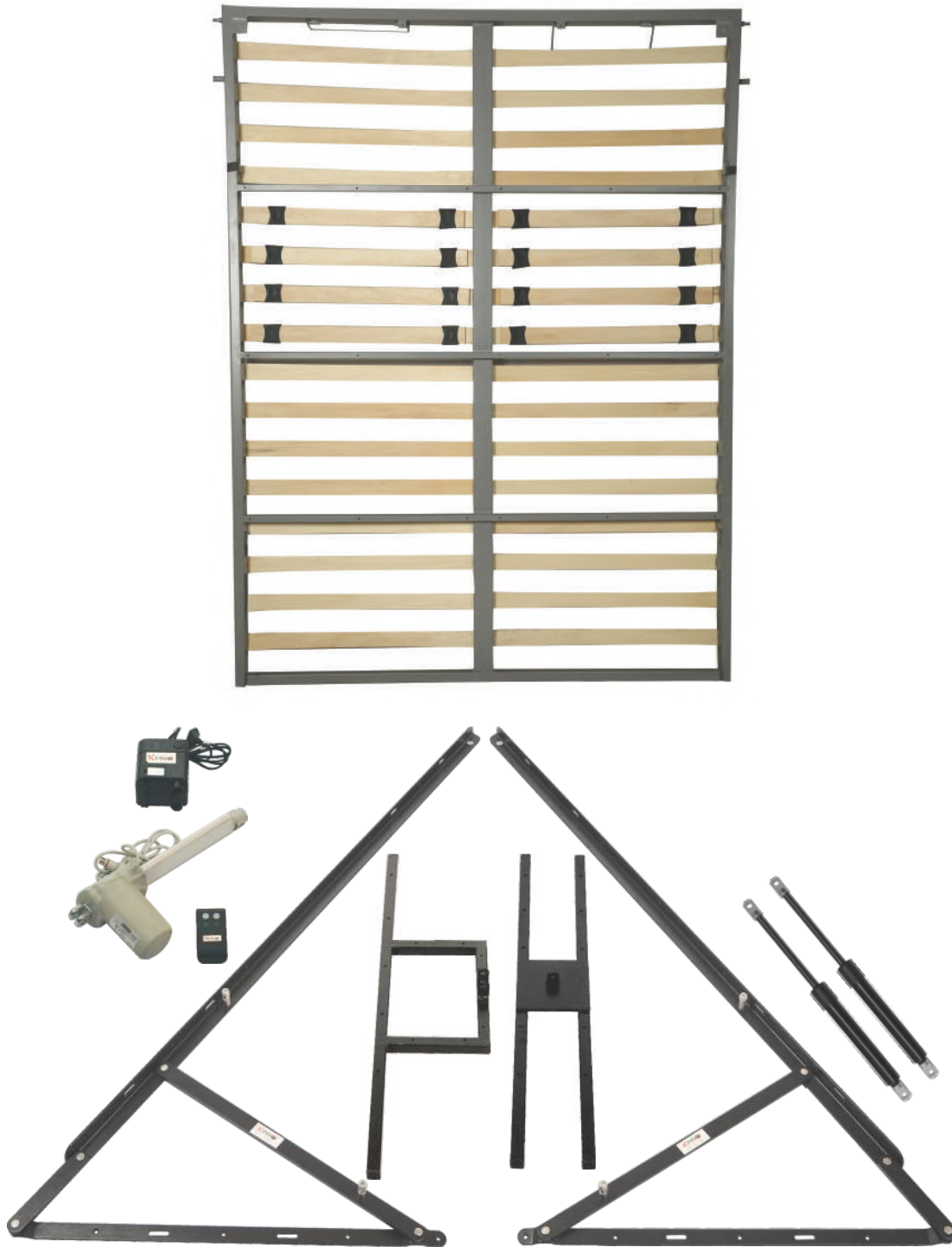

Code : 9017

Material : Mild Steel & Wood Slats

Size :

915mm x 1905mm (3ft x 6¼ft)
1535mm x 1905mm (5ft x 6¼ft)
1680mm x 1980mm (5½ft x 6½ft)
1830mm x 1980mm (6ft x 6½ft)

and customised sizes available.

Finish : Munshell Grey

Load Capacity : 0kg to 300kg

K^{PRO}® BED TOP FRAME WITH BED FITTINGS

(BED FITTING FRAME) (5mm)



Code : 9018

Material : Mild Steel & Wood Slats

Size :

915mm x 1905mm (3ft x 6¼ft)
1535mm x 1905mm (5ft x 6¼ft)
1680mm x 1980mm (5½ft x 6½ft)
1830mm x 1980mm (6ft x 6½ft)

and customised sizes available.

Finish : Munshell Grey

BED TOP FRAME

KPRO®



Code : 9019

Material : Mild Steel & Wood Slats

Size :

915mm x 1905mm (3ft x 6¼ft)
1535mm x 1905mm (5ft x 6¼ft)
1680mm x 1980mm (5½ft x 6½ft)
1830mm x 1980mm (6ft x 6½ft)

and customised sizes available.

Finish : Munshell Grey



(BED TOP FRAME WITH FITTINGS)

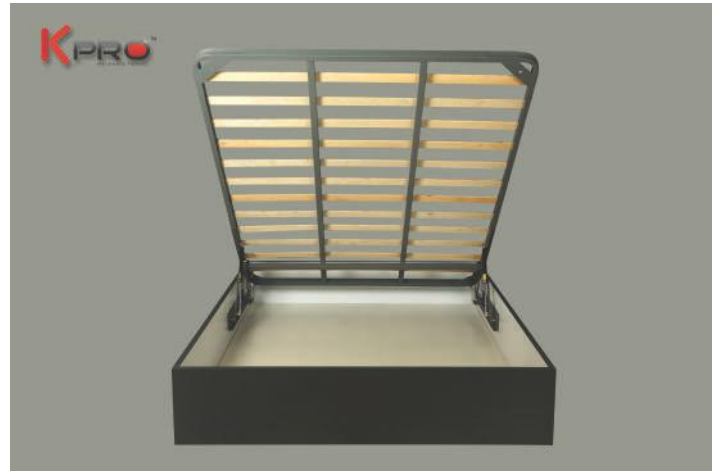
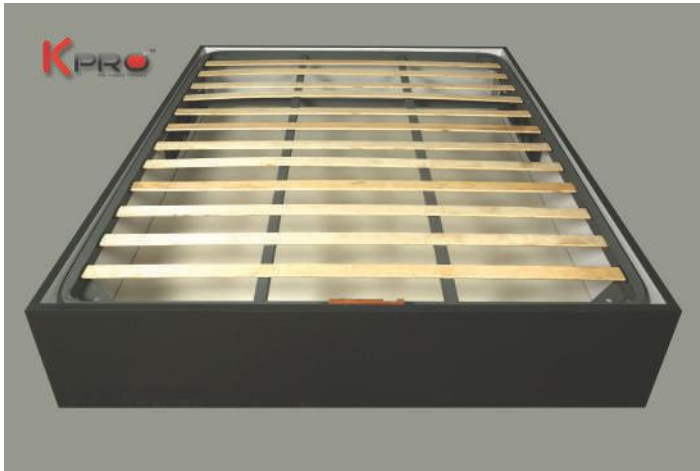

Code : 9020

Material : Mild Steel & Wood Slats

Size :

915mm x 1905mm (3ft x 6¼ft)
1535mm x 1905mm (5ft x 6¼ft)
915mm x 1905mm (3ft x 6¼ft)
915mm x 1905mm (3ft x 6¼ft)

and customised sizes available.

Finish : Munshell Grey

METAL FITTINGS

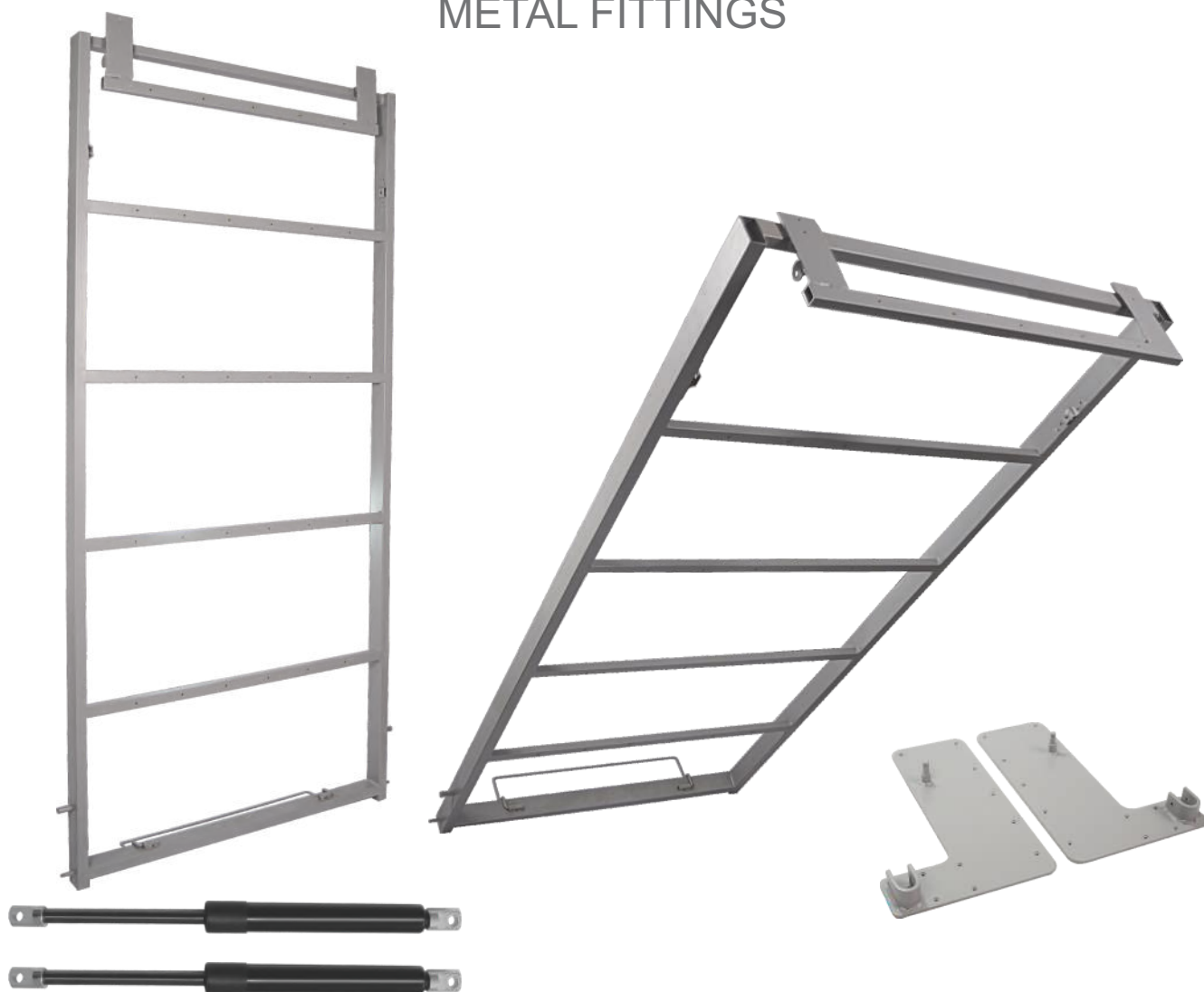

Code : 9021

Material : CRW PIPE (Mild Steel)

Size	915mm x 1905mm (3ft x 6¼ft)
	1535mm x 1905mm (5ft x 6¼ft)
	1680mm x 1980mm (5½ft x 6½ft)
	1830mm x 1980mm (6ft x 6½ft)

and customised sizes available.

Finish : Munshell Grey

Gas : 17" - 50kg, 75kg, 100kg, 125kg,

Pump : 150kg, 175kg, 200kg



(WIRELESS REMOTE OPERATED)



Code : 9022

Material : CRW PIPE (Mild Steel) & Wood Slats

Size :

915mm x 1905mm (3ft x 6¼ft)
1535mm x 1905mm (5ft x 6¼ft)
1680mm x 1980mm (5½ft x 6½ft)
1830mm x 1980mm (6ft x 6½ft)

and customised sizes available.

Finish : Munshell Grey

Load

Capacity: 0kg to 300kg

WALL MOUNTING BED



(MANUALLY OPERATED)



Code : 9023

Material : CRW PIPE (Mild Steel) & Wood Slats

Size :	915mm x 1905mm (3ft x 6¼ft)
	1535mm x 1905mm (5ft x 6¼ft)
	1680mm x 1980mm (5½ft x 6½ft)
	1830mm x 1980mm (6ft x 6½ft)

and customised sizes available.

Finish : Munshell Grey

Gas : 17" - 50kg, 75kg, 100kg, 125kg,

Pump : 150kg, 175kg, 200kg

(WIRELESS REMOTE OPERATED)



Code : 9024

Material : Mild Steel & Wood Slats

Size :	915mm x 1905mm (3ft x 6¼ft)
	1535mm x 1905mm (5ft x 6¼ft)
	1680mm x 1980mm (5½ft x 6½ft)
	1830mm x 1980mm (6ft x 6½ft)

and customised sizes available.

Finish : Munshell Grey

Load

Capacity: 0kg to 300kg

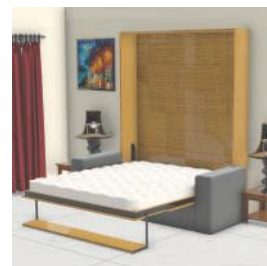

WALL MOUNTING SOFA CUM BED FITTINGS

KPRO[®]

(MANUALLY OPERATED)



Code : 9025

Material : Mild Steel & Wood Slats

Size :	915mm x 1905mm (3ft x 6¼ft)
	1535mm x 1905mm (5ft x 6¼ft)
	1680mm x 1980mm (5½ft x 6½ft)
	1830mm x 1980mm (6ft x 6½ft)

and customised sizes available.

Finish : Munshell Grey

Gas : 17" - 50kg, 75kg, 100kg, 125kg,

Pump : 150kg, 175kg, 200kg

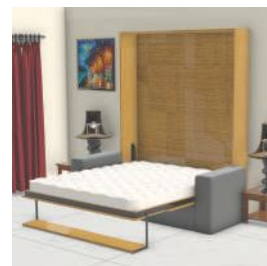

(WIRELESS REMOTE OPERATED)



Code : 9026

Material : Mild Steel & Wood Slats

Size : 915mm x 1905mm (3ft x 6¼ft)
and customised sizes available.

Finish : Munshell Grey

Load

Capacity: 0kg to 300kg

WALL MOUNTING HORIZONTAL BED

KPRO®

(MANUALLY OPERATED)



Code : 9027

Material : Mild Steel & Wood Slats

Size : 915mm x 1905mm (3ft x 6¼ft)
and customised sizes available.

Finish : Munshell Grey

Gas : 17" - 50kg, 75kg, 100kg, 125kg,

Pump : 150kg, 175kg, 200kg

WALL MOUNTING BED CUM HEAVY DINING TABLE

(WIREFLESS REMOTE OPERATED)



Code : 9028

Material : Mild Steel & Wood Slats

Size	915mm x 1905mm (3ft x 6¼ft)
	1535mm x 1905mm (5ft x 6¼ft)
	1680mm x 1980mm (5½ft x 6½ft)
	1830mm x 1980mm (6ft x 6½ft)

and customised sizes available.

Finish : Munshell Grey

Load

Capacity: 0kg to 300kg

WALL MOUNTING BED CUM HEAVY DINING TABLE

KPRO[®]

(MANUALLY OPERATED)



Code : 9029

Material : Mild Steel & Wood Slats

Size	915mm x 1905mm (3ft x 6¼ft)
	1535mm x 1905mm (5ft x 6¼ft)
	1680mm x 1980mm (5½ft x 6½ft)
	1830mm x 1980mm (6ft x 6½ft)

and customised sizes available.

Finish : Munshell Grey

Gas : 17" - 50kg, 75kg, 100kg, 125kg,

Pump : 150kg, 175kg, 200kg

WALL MOUNTING BED CUM WRITING TABLE

(WIRELESS REMOTE OPERATED)



Code : 9030

Material : Mild Steel & Wood Slats

Size :	915mm x 1905mm (3ft x 6¼ft)
	1535mm x 1905mm (5ft x 6¼ft)
	1680mm x 1980mm (5½ft x 6½ft)
	1830mm x 1980mm (6ft x 6½ft)

and customised sizes available.

Finish : Munshell Grey

Load

Capacity: 0kg to 300kg

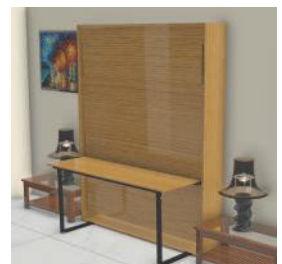

WALL MOUNTING BED CUM WRITING TABLE

KPRO®

(MANUALLY OPERATED)



Code : 9031

Material : Mild Steel & Wood Slats

Size :

915mm x 1905mm (3ft x 6¼ft)
1535mm x 1905mm (5ft x 6¼ft)
1680mm x 1980mm (5½ft x 6½ft)
1830mm x 1980mm (6ft x 6½ft)

and customised sizes available.

Finish : Munshell Grey

Gas : 17" - 50kg, 75kg, 100kg, 125kg,

Pump : 150kg, 175kg, 200kg





Code : 9032

Material : Mild Steel and Wood Sluts

Size : 915mm x 1905mm (3' X 6¼')
and customised sizes available.

Finish : Munshell Grey

Gas : 17" - 50kg, 75kg, 100kg, 125kg,

Pump : 150kg, 175kg, 200kg



Code : 9033

Material : Aluminium, Mild Steel, PVC Parts, Remote, Motors

Finish : Metallic Silver

Size : For 32" and 42" size TV's



WALL MOUNTING BED SIDE LEGS

Code : 9034

Material : Mild Steel

Finish : Metallic Silver

Gas Pump : 17" - 50kg, 75kg, 100kg, 125kg,
150kg, 175kg, 200kg



ECONOMIC



CODE	DESCRIPTION	SIZE	FINISH	REMARKS	BOX PACK
9035	DINING TABLE FITTING (ALUMINIUM & MILD STEEL)	36 INCH.	STONE GREY	1 SET PKG.	10 SETS
9036	DINING TABLE FITTING (ALUMINIUM & MILD STEEL)	42 INCH.	STONE GREY	1 SET PKG.	10 SETS
9037	DINING TABLE FITTING (ALUMINIUM & MILD STEEL)	48 INCH.	STONE GREY	1 SET PKG.	6 SETS
9038	DINING TABLE FITTING (ALUMINIUM & MILD STEEL)	60 INCH.	STONE GREY	1 SET PKG.	6 SETS

PREMIUM



CODE	DESCRIPTION	SIZE	FINISH	REMARKS	BOX PACK
9039	DINING TABLE FITTING (ALUMINIUM)	24 INCH.	BROWN ANODIZED	1 SET PKG.	10 SETS
9040	DINING TABLE FITTING (ALUMINIUM)	30 INCH.	BROWN ANODIZED	1 SET PKG.	10 SETS
9041	DINING TABLE FITTING (ALUMINIUM)	36 INCH.	BROWN ANODIZED	1 SET PKG.	10 SETS
9042	DINING TABLE FITTING (ALUMINIUM)	42 INCH.	BROWN ANODIZED	1 SET PKG.	10 SETS
9043	DINING TABLE FITTING (ALUMINIUM)	48 INCH.	BROWN ANODIZED	1 SET PKG.	6 SETS
9044	DINING TABLE FITTING (ALUMINIUM)	60 INCH.	BROWN ANODIZED	1 SET PKG.	4 SETS

PLATINIUM



Code : 9045

Material : Aluminium, Mild Steel, PVC Parts

Size :

Length	Width	Height
1480mm	600mm	705mm

Finish : Silver Anodized



SHOES SITTING TABLE

Code : 9046
Material : Mild Steel
Finish : Black
Packing : 10 set



CONCEALED TABLE

Code : 9047
Material : Mild Steel
Finish : Black
Packing : 10 set



SOFA CUM BED FITTINGS

Code : 9048
Material : Mild Steel
Finish : Black
Packing : 10 set

CENTRE TABLE TO DINING FOLDING SYSTEM

KPRO®

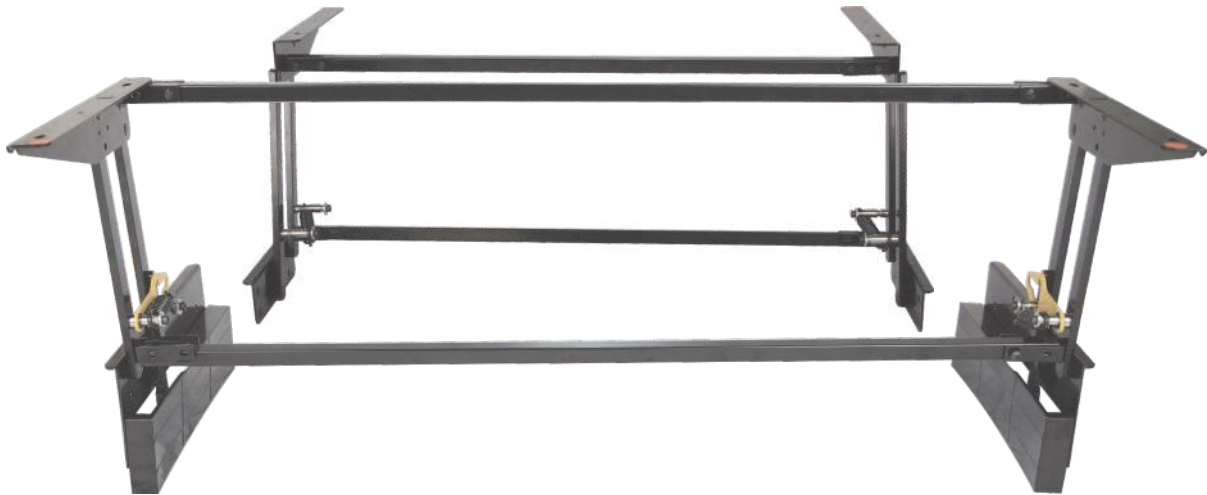

Code : 9049

Material : Mild Steel

Box Size :

Length	Width	Height
940mm	500mm	407mm

Finish : Black Powder Coated



(TECHNICAL DRAWING)

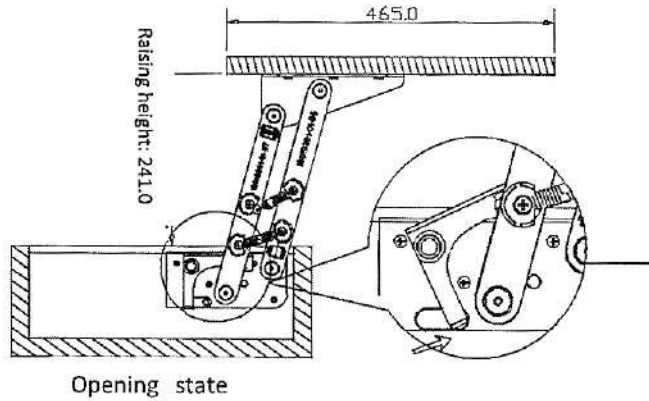

Warm prompt: the mechanism lock automatically when you lift it up totally. If you want to close it, please unlock it by hand.
 Note: please unlock according to arrow direction.

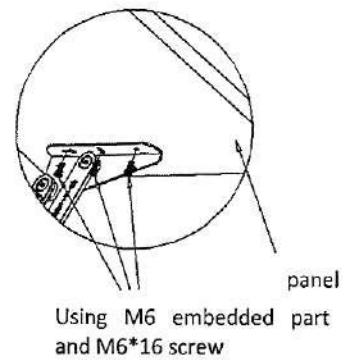
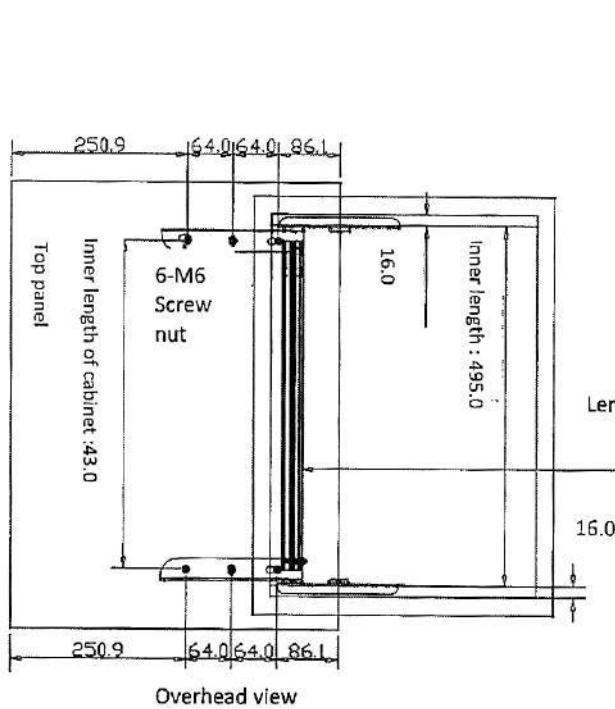
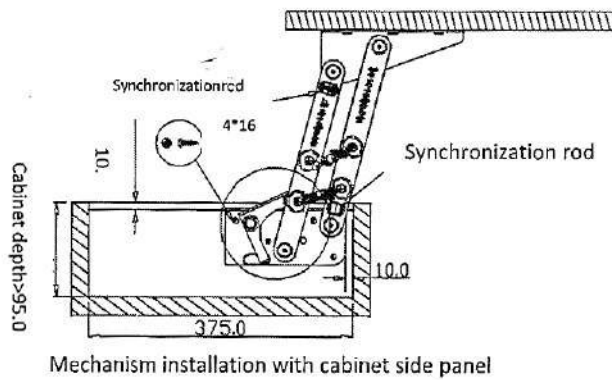
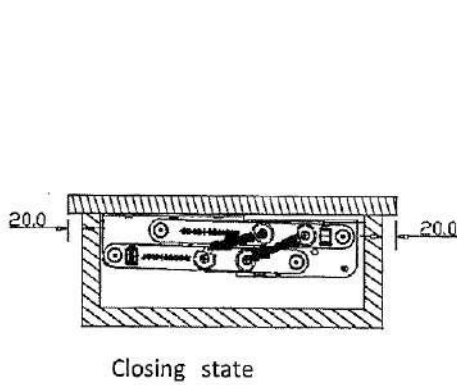

Length of Synchronization rod = inner length of cabinet - 50.0

Note: this installation manual takes 495mm cabinet inner length as reference.
 Cabinet body and top panel can be changed as requirement (just change spring).

CENTRE TABLE SYSTEM

KPRO®

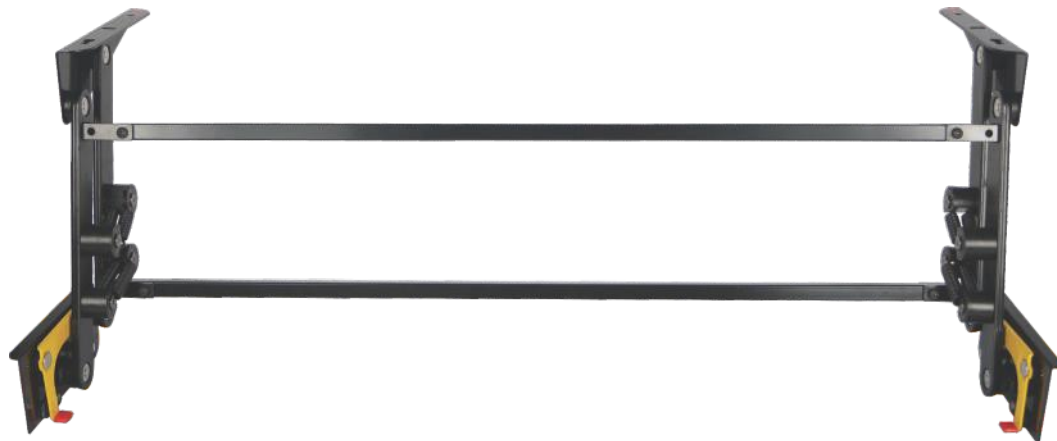

Code : 9050

Material : Mild Steel

Box Size :

Length	Width	Height
975mm	414mm	375mm

Finish : Black Powder Coated





INDEX

TOPICS

PAGE

Sliding Door System :	32 - 49
Inline / Top Line Fittings & Channels /	
Folding Door Sliding & Channels / Soft Close Compress	
System & Channels / Soft Close Slim System & Channels /	
Four & Eight Wheels Both Side Soft Close & Channels /	
Four & Eight Wheels & Channels / Double Door System &	
Double Door Soft Close System & Channels / Compact Door	
System & Channels / Slide Line & Channels	
 Ladders	 50

(IN LINE TECHNICAL DRAWING)

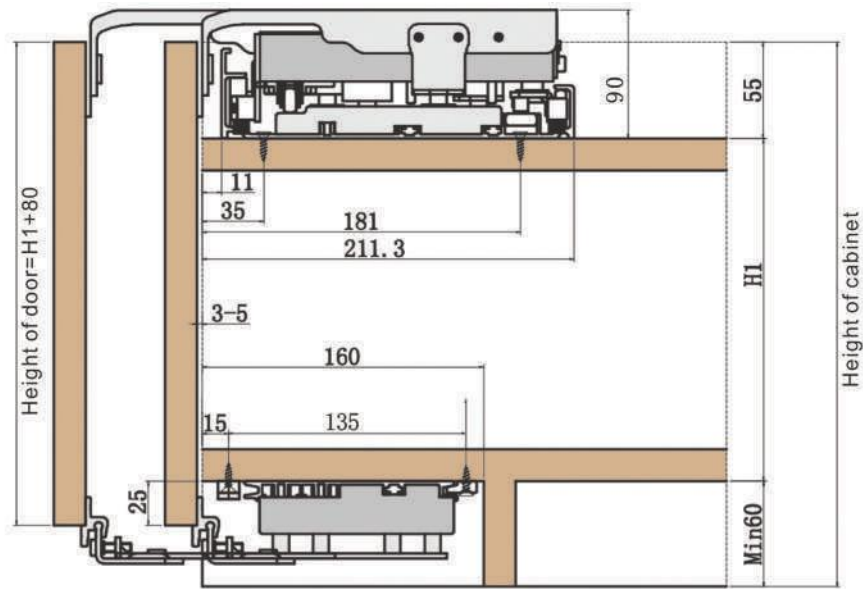

Thickness of door 18-45mm (Handle included)

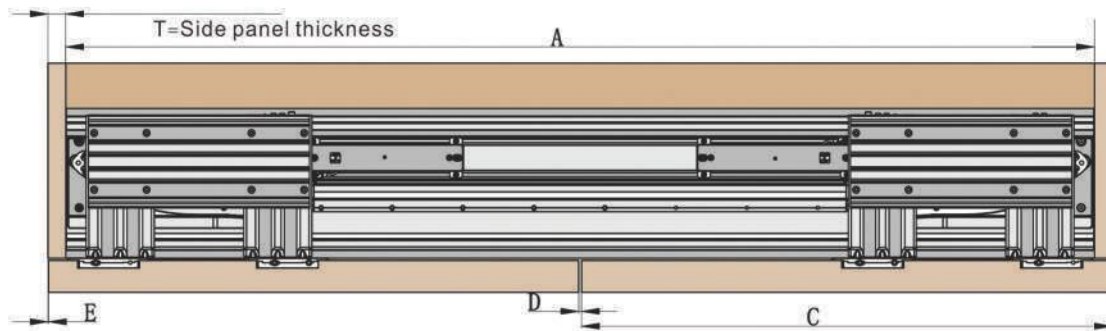

A=inner width of cabinet

D=gap between two doors (3-5mm)

E=gap between side panel and door

$C = \text{width of door} = \frac{(A + 2T - 2E - D)}{2}$

Cabinet Requirements

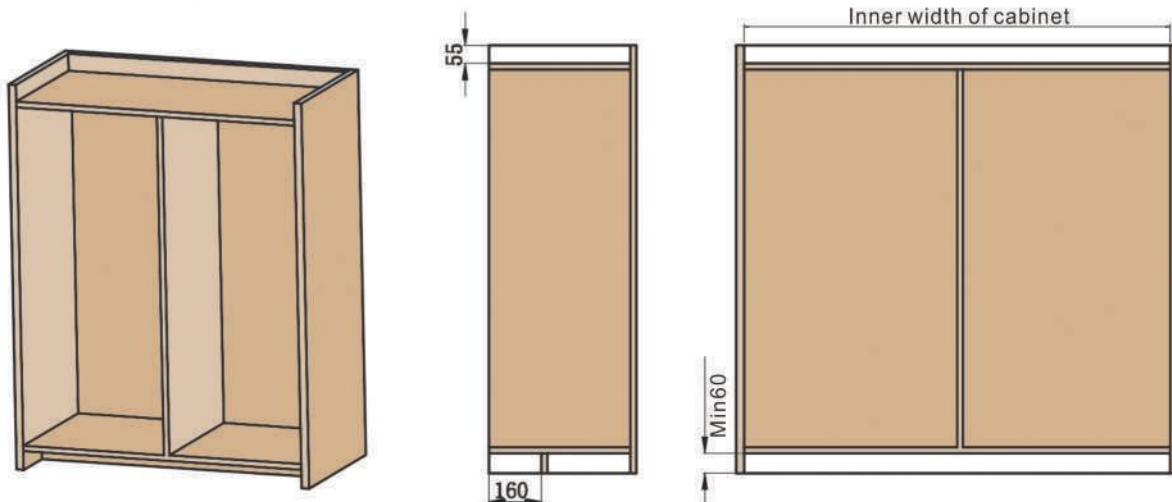

SLIDING DOOR SYSTEM

KPRO®

IN LINE

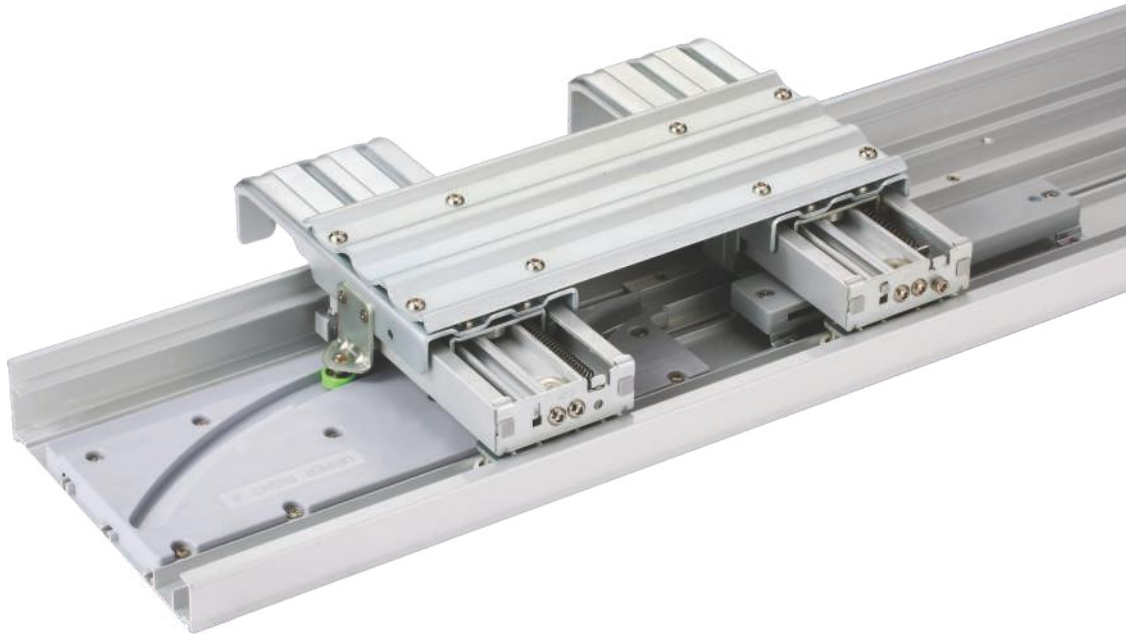

- Code** : 9051
- Material** : Aluminium, Mild Steel, PVC Parts
- Size** : 1950mm
2100mm
2250mm
2400mm
- Finish** : Metallic Silver
- Load Capacity** : 60kg/door
- Door Thickness** : 18mm to 45mm
- Packing** : Two Door Kit



TOP LINE

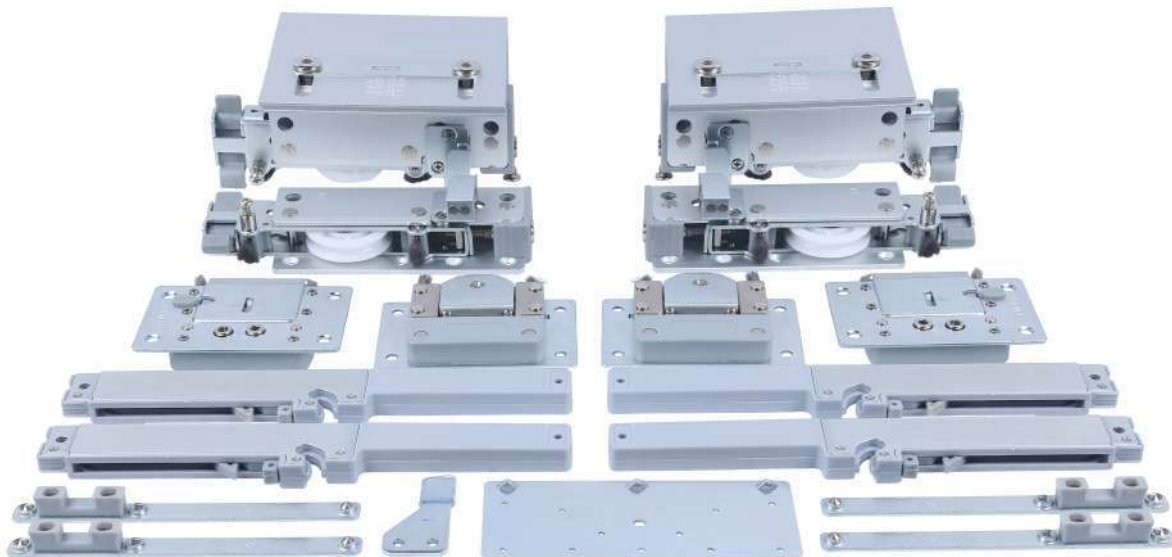

Code : 9052
Material : Alluminium, Mild Steel, PVC Parts
Finish : Metallic Silver
Load Capacity : 60kg
Door Thickness : 18mm to 45mm
Packing : Two Door Kit

SLIDING DOOR SYSTEM TOP LINE CHANNEL

Code : 9053
Material : Alluminium
Finish : Silver Anodized
Size : 3 meters



(FOLDING DOOR SYSTEM TECHNICAL DRAWING)

- Installation instruction:**
1. Installation of accessories: As shown in the installation diagram, on the right door panel edge, drill a 48mm-deep $\varnothing 10$ mm hole on the top, a 32mm-deep hole at the bottom, to respectively install the upper and lower fixed rotating shafts. In the position of at least 55mm from the edge of left door panel, drill two $\varnothing 10$ mm, 26mm-deep holes, one on the top, the other at the bottom. Install the hanging piece of hanging wheel on the top, the lower guide wheel at the bottom.
 2. Installation of invisible hinge: For the specific location and hole size, please refer to the installation diagram.
 3. Cut the top and bottom tracks according to the required space. Slide the hanging wheel into the track from the side of top overhead rail. Install the seat of the upper fixed rotating shaft in the fit between the right side of top overhead rail and the upper fixed rotating shaft.
 4. Fixation of top overhead rail: Adjust the position of top overhead rail. Fasten the top overhead rail with screws, to keep it in horizontal position.
 5. Adjust the fit between the door and the top overhead rail. Lock the hanging piece and hanging wheel tightly together with nuts.
 6. Place the lower guide wheel into the lower guide rail, and fasten the seat of the lower fixed rotating shaft with M4x30 countersunk head screw. Adjust the position of the lower fixed rotating shaft and the rotating shaft seat to make them fit.
 7. Adjust until the gap is uniform and the top and bottom tracks are parallel to each other. Then fasten the lower guide rail. When the pulley can flexibly rotate, retighten the nuts before use.

- Notes:**
1. As the bearing capacity of hanging wheels is 40kg, it is suggested that the door to be installed should not be more than 40kg;
 2. The applicable door is 20~27mm thick. The invisible hinge is usually installed at the middle of the door thickness. If the thickness is over 27mm, the invisible hinge may be biased.
 3. B should be 5~10mm greater than A.

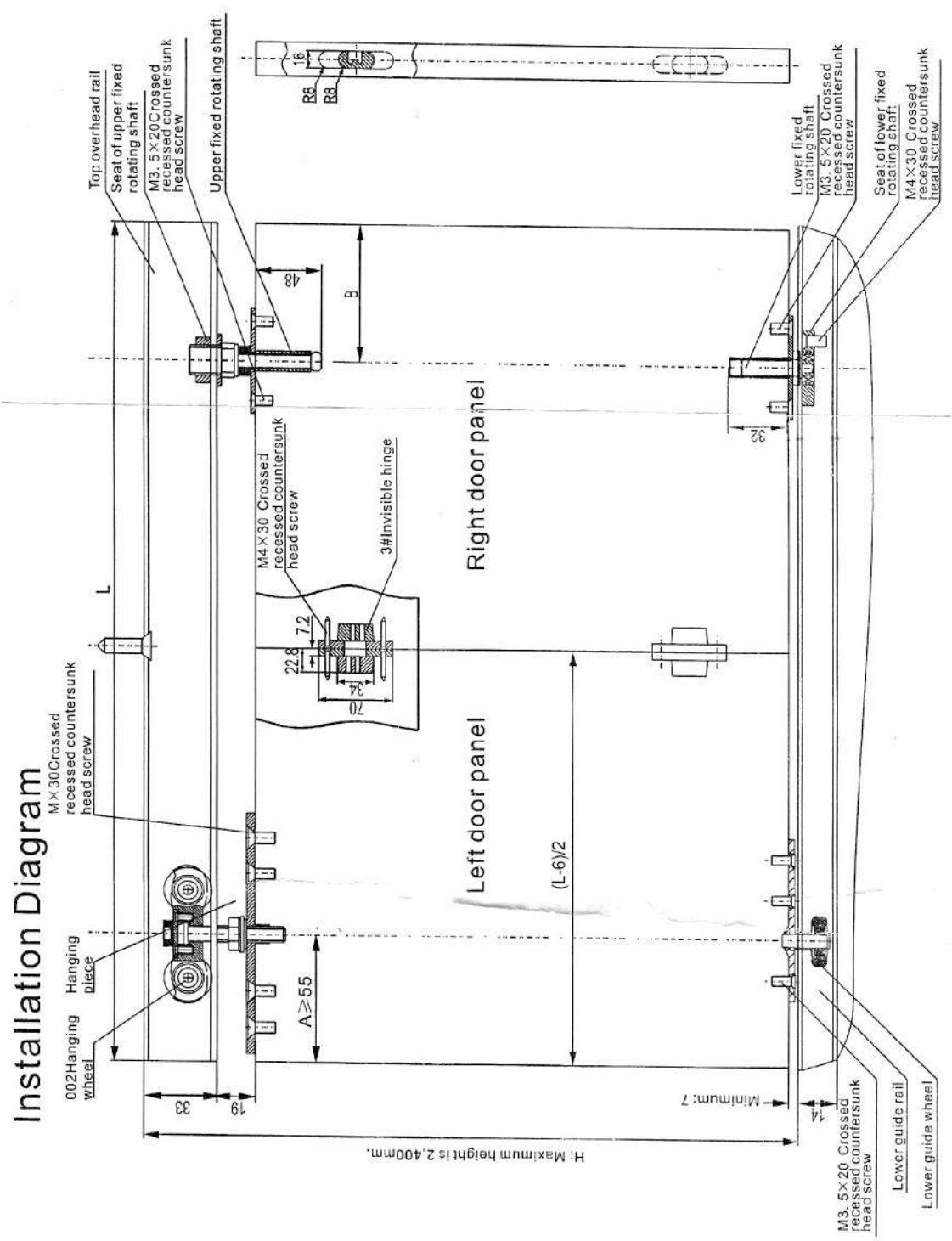

FOLDING DOOR SLIDING SYSTEM



Code : 9054
Material : Alluminium, Mild Steel, PVC Parts
Finish : Metallic Silver
Load Capacity : 60kg
Door Thickness : 18mm to 45mm
Packing : Two Door Kit

SLIDING DOOR SYSTEM FOLDING DOOR FITTING CHANNEL

Code : 9055
Material : Alluminium
Finish : Silver Anodized
Size : 3 meters



(SOFT CLOSING

Accessories Options: COMPRESS SYSTEM TECH. DRAWING)



A. Luxury



B. Practical



C. Standard [≤40kg]



D. Economy

Installation steps:

1 Installation stopper and track

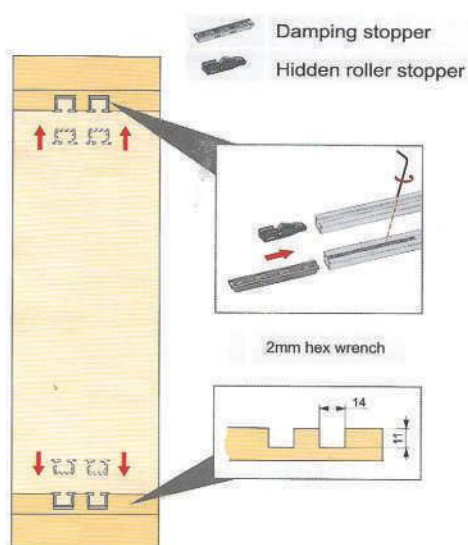

2 Installation accessories

1 Roller holes dimension

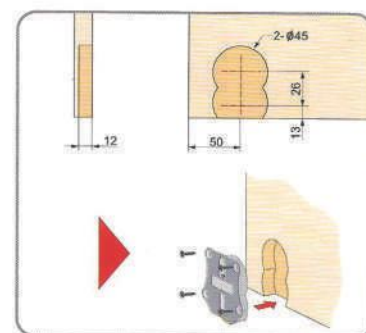
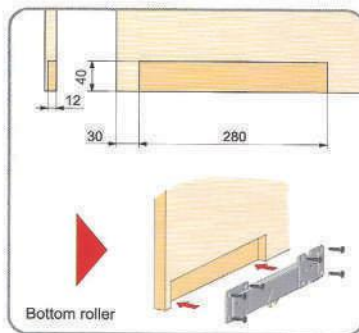
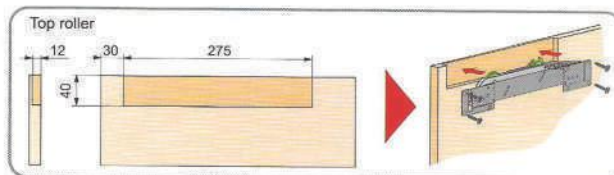

2 Install rollers

Top and bottom damping rollers installation of similar

3 Install door (doors size count)

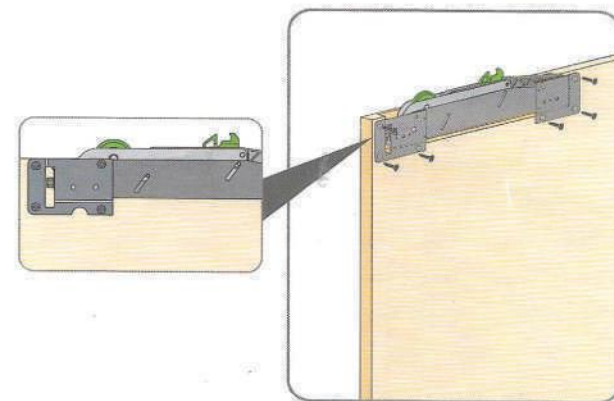
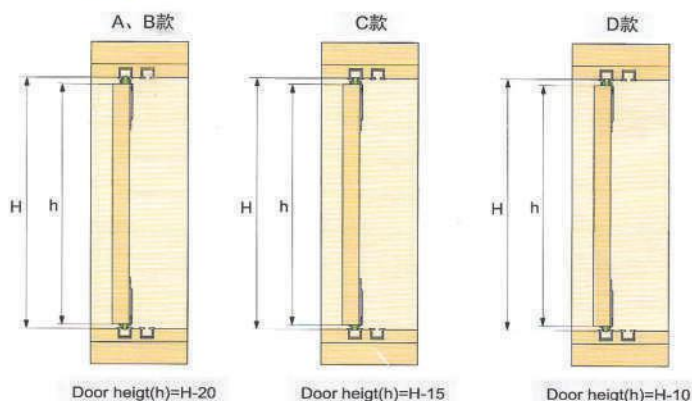

4 Adjust the door

2 Adjust the door damping (adjust damping stopper)

1 Adjust the door balance (adjust the bottom rollers)

8mm outside-hexagonal spanner

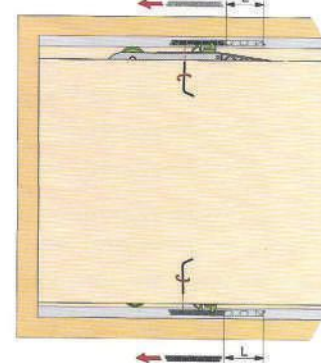
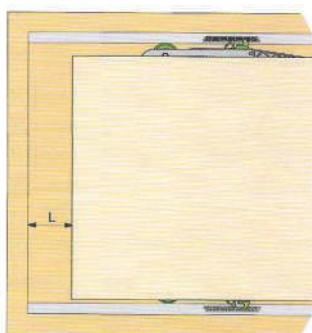
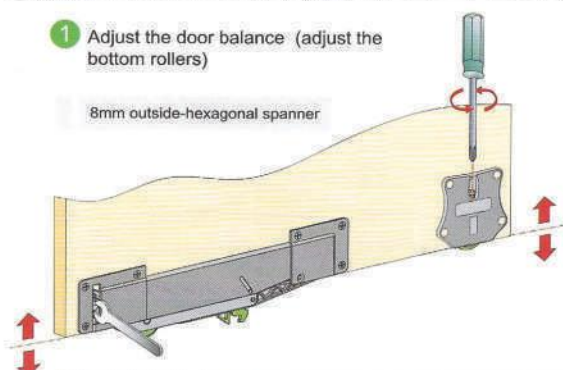

SOFT CLOSING COMPRESS SYSTEM

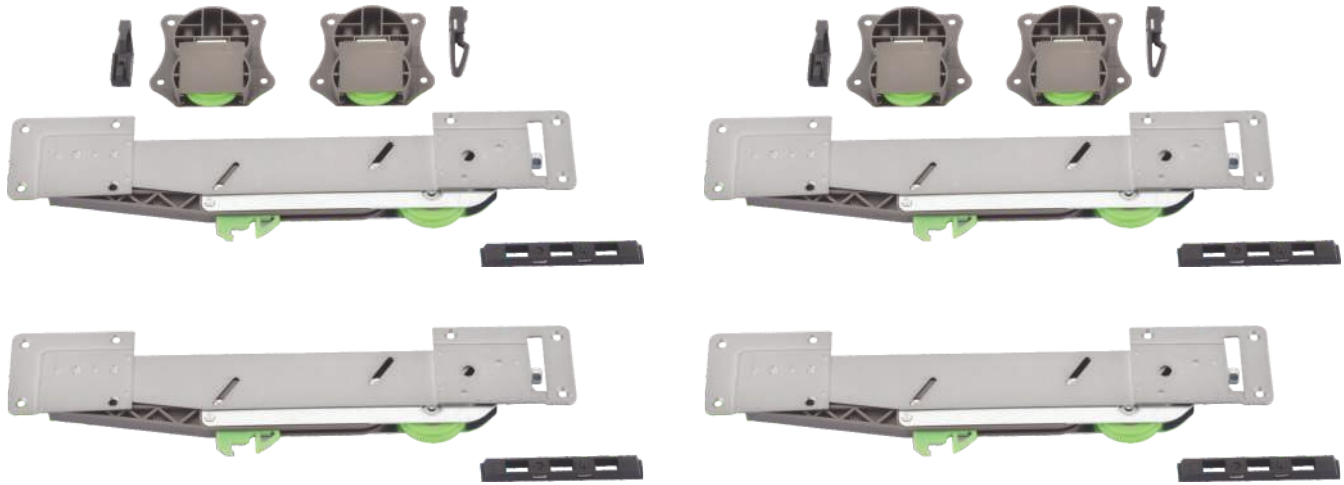

- Code** : 9056
- Material** : Alluminium, Mild Steel, PVC Parts
- Finish** : Metallic Silver
- Load Capacity** : 40kg
- Door Thickness** : 18mm to 35mm
- Packing** : Two Door Kit

SLIDING DOOR SYSTEM SOFT CLOSE COMPRESS SYSTEM CHANNEL



- Code** : 9057
- Material** : Alluminium
- Finish** : Silver Anodized
- Size** : 3 meters

(SOFT CLOSING SLIM SYSTEM TECHNICAL DRAWING)

1. Damper installation

Put damper inside the rail, attention direction of damper.

60mm left between damper and end of rail.

2. Rail installation

Attention direction.

3. Plastic end function

4. Set up the damper

Damper install on the upper track.

Turn the screw of end cap to take out the rail

According to picture

5. Slot on door panel

Regulate the damper according to picture

make slot symmetric

slot size:

6. Runner installation

1. Screw the runner

2. Lock the runner

Attention: runner should be horizontal during installation

7. Door panel installation

1. Door can't be lean over 20 degree on rail in case of breaking rail

2. Loose the button on runner

8. Door gap regulation

1. Push the door at the end to position the damper.

2. Screw the runner to regulate up and down gap

9. Lock the damper

Use allen key lock the damper

10. Remark

1. This manual is only valid at the standard configurations of wardrobe to explain installation method which installs the damper into the upper rail. Customers can use different installation method according to the actual application. The damper should be installed in the same time as the opposite angles installation; and also can use double upper dampers or double down dampers installation in the same time. or

2. T305 product also apply to solid wood or board furniture, such as wardrobe, cupboard cabinet, bookcase, TV cabinet, Decoration cabinet etc.

Size on wardrobe

Customers can definite by their own.

Aluminum rail length

Slot dimension for aluminum rail

SOFT CLOSING SLIM SYSTEM

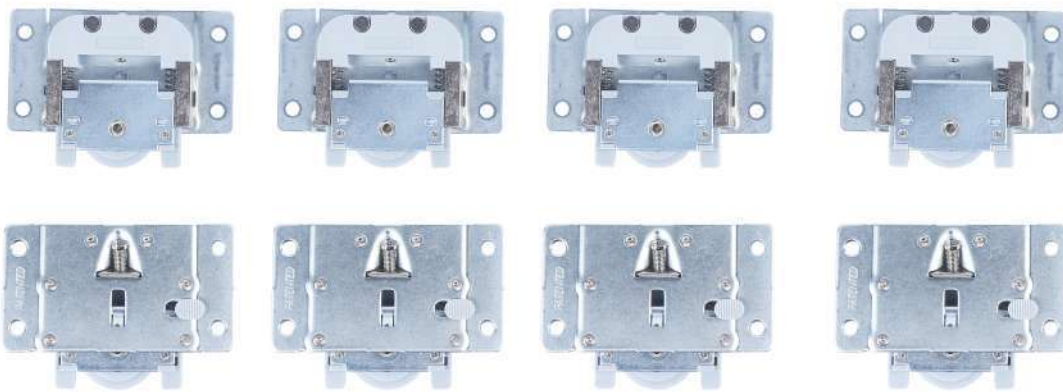

Code : 9058
Material : Alluminium, Mild Steel, PVC Parts
Finish : Metallic Silver
Load Capacity : 40kg
Door Thickness : 18mm to 35mm
Packing : Two Door Kit

SLIDING DOOR SYSTEM SOFT CLOSE SLIM SYSTEM CHANNEL



Code : 9059A
Material : Alluminium
Finish : Silver Anodized
Size : 8 feet, 12 feet
Weight per foot : 0.230gms



Code : 9059B
Material : Alluminium
Finish : Silver Anodized
Size : 3 meters

1 Install the rollers and stir button

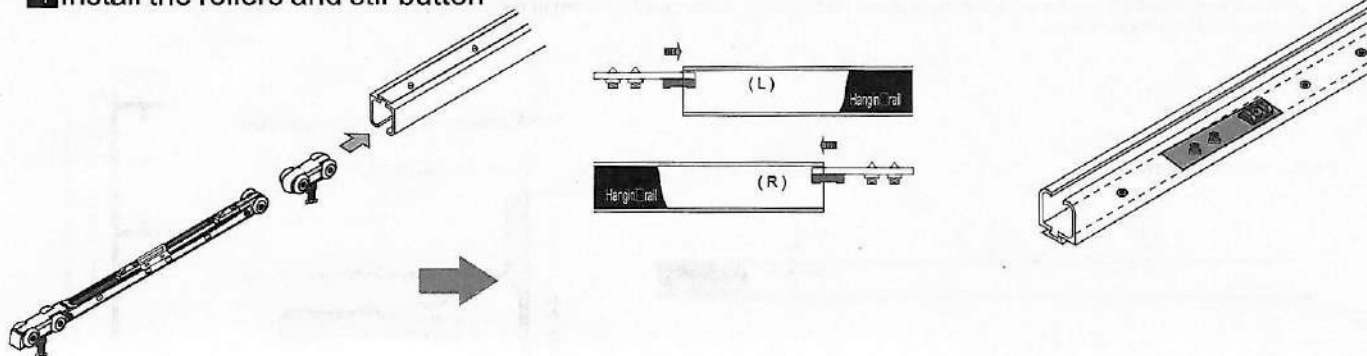

1. Fix the rollers into the upper rail, as the above pic shows

2. Put the two stir buttons into the rail directly above

3. Please ensure the installation direction is correct (as pic shows). Otherwise, the stir button will be unusable

2 Fixing the upper rail and stopper

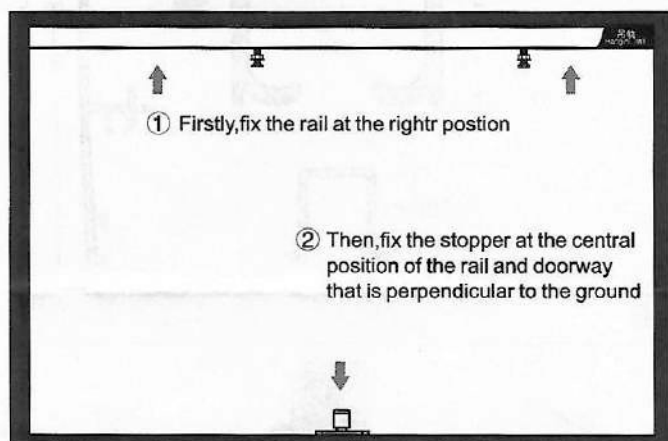

3 Hang the door and adjustment

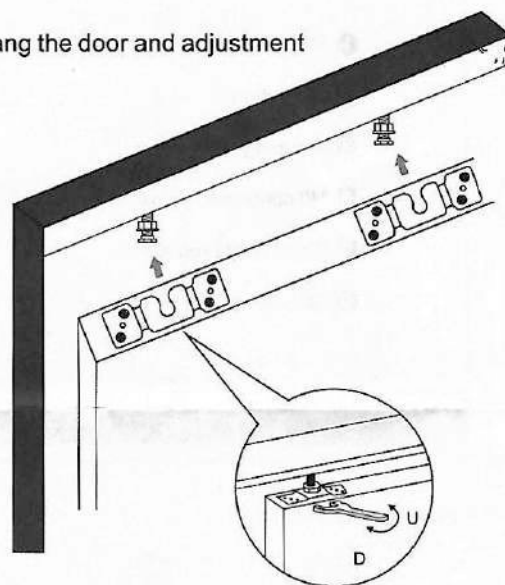

4 Stir button adjustment

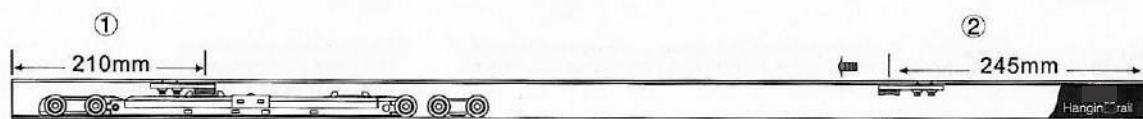

① The margin (Fixed value) between the stir button and rail end is 210mm

⚠ ② The margin (variable value) between the stir button and rail end = door width - 550mm + 245mm

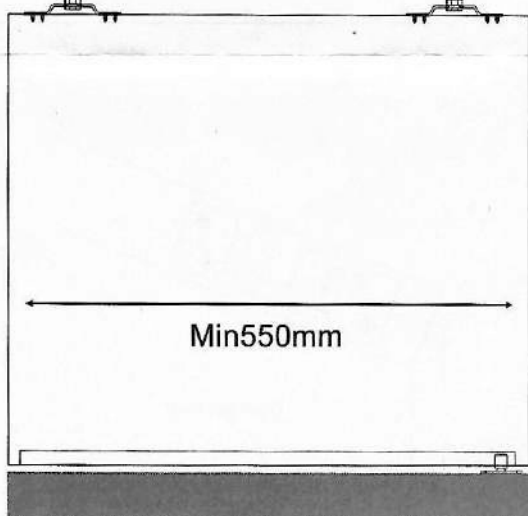

BOTH SIDE SOFT CLOSING SYSTEM (FOUR WHEELS)

- Code** : 9060
- Material** : Alluminium, Mild Steel, PVC Parts
- Finish** : Metallic Silver
- Load Capacity** : 40kg
- Door Thickness** : 18mm to 35mm
- Packing** : Single Door Kit



SLIDING DOOR SYSTEM BOTH SIDE SOFT CLOSE SYSTEM CHANNEL

IMPORTED

- Code** : 9061
- Material** : Alluminium
- Finish** : Silver Anodized
- Size** : 3 meters



(SOFT CLOSING SYSTEM TECH. DRAWING (EIGHT WHEELS))

1 Install the rollers and stir button

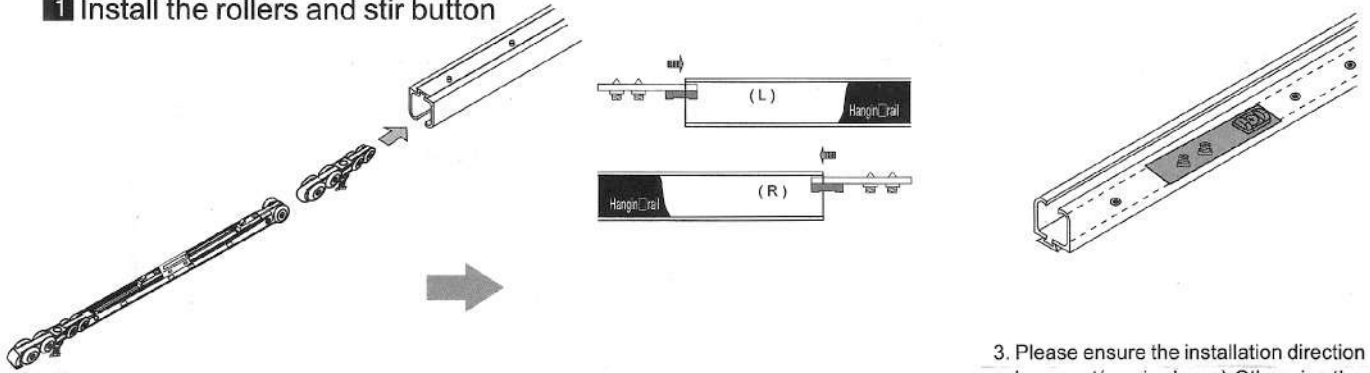

1. Fix the rollers into the upper rail, as the above pic shows

2. Put the two stir buttons into the rail directly above

3. Please ensure the installation direction is correct (as pic shows). Otherwise, the stir button will be unusabl

2 Fixing the upper rail and stopper

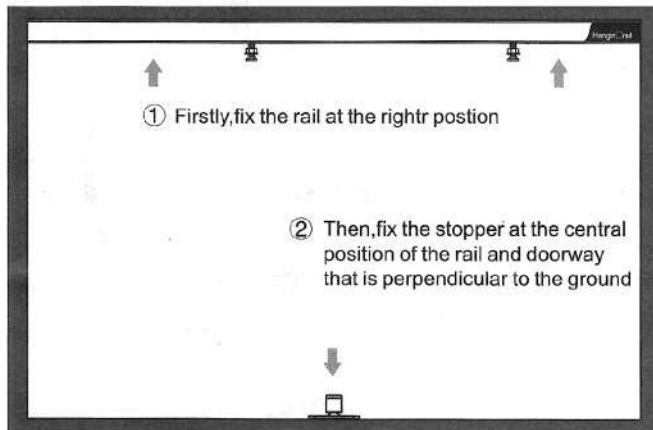

3 Hang the door and adjustment

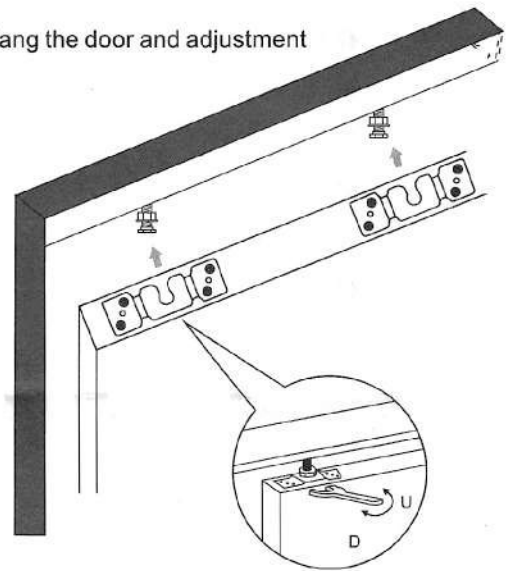

4 Stir button adjustment



① The margin (Fixed value) between the stir button and rail end is 235mm

⚠ ② The margin (variable value) between the stir button and rail end = door width - 600mm + 270mm

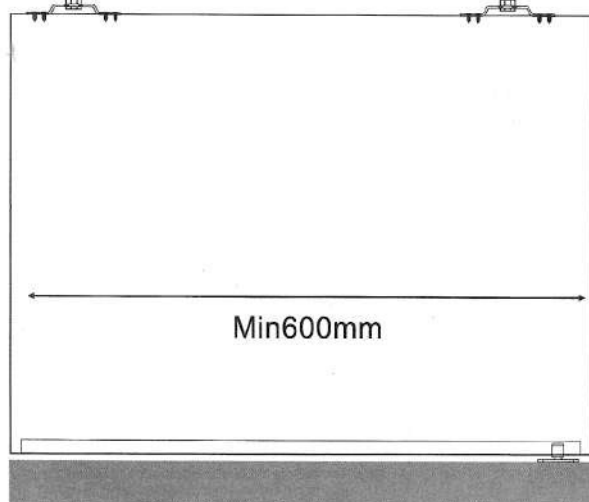

BOTH SIDE SOFT CLOSING SYSTEM (EIGHT WHEELS)

- Code** : 9062
Material : Alluminium, Mild Steel, PVC Parts
Finish : Metallic Silver
Load Capacity : 60kg
Door Thickness : 18mm to 45mm
Packing : Single Door Kit



SLIDING DOOR SYSTEM BOTH SIDE SOFT CLOSE SYSTEM CHANNEL

IMPORTED

- Code** : 9063
Material : Alluminium
Finish : Silver Anodized
Size : 3 meters



FOUR WHEELS



Code : 9064
Material : Stainless Steel, White Metal
Finish : SS Brush
Load Capacity : 40kg
Door Thickness : 18mm to 35mm
Packing : Single Door Kit

EIGHT WHEELS



Code : 9065
Material : Stainless Steel, White Metal
Finish : SS Brush
Load Capacity : 60kg
Door Thickness : 18mm to 45mm
Packing : Single Door Kit

SLIDING DOOR SYSTEM
 BOTH SIDE SOFT CLOSE SYSTEM CHANNEL

NATURAL ALLUMINIUM FINISH



Code : 9066A
Material : Alluminium
Size : 8 Feet, 12 Feet
Weight per foot : 0.150gms
Finish : Alluminium

ANODIZED FINISH



Code : 9066B
Material : Alluminium
Size : 8 Feet, 12 Feet
Weight per foot : 0.190gms
Finish : Anodized

DOUBLE DOOR

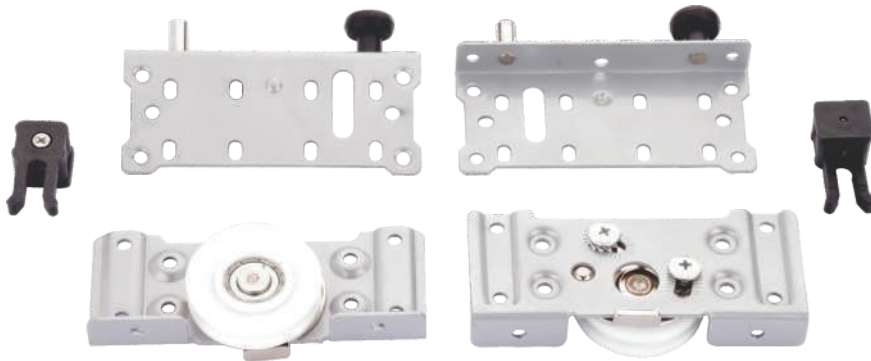

Code : 9067
Material : Mild Steel and Darlin Parts
Finish : Silver Coated
Load Capacity : 25kg
Door Thickness : 18mm
Packing : Single Door Kit

DOUBLE DOOR SOFT CLOSE

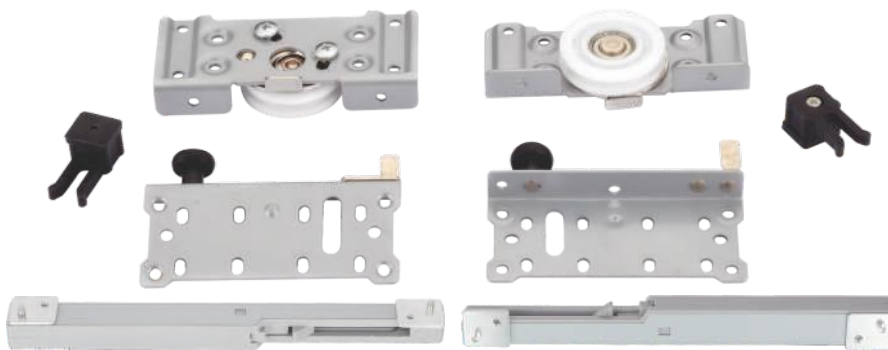

Code : 9068
Material : Mild Steel and Darlin Parts
Finish : Silver Coated
Load Capacity : 25kg
Door Thickness : 18mm
Packing : Single Door Kit

SLIDING DOOR SYSTEM DOUBLE DOOR CHANNEL

**NATURAL
ALLUMINIUM
FINISH**



Code : 9069A
Material : Alluminium
Finish : Alluminium
Size : 6.5 Feet, 8 Feet, 10 Feet, 12 Feet, 13 Feet
Weight per feet : 0.210gms

**ANODIZED
FINISH**



Code : 9069B
Material : Alluminium
Finish : Anodized
Size : 6.5 Feet, 8 Feet, 10 Feet, 12 Feet, 13 Feet
Weight per feet : 0.210gms

COMPACT DOOR SYSTEM

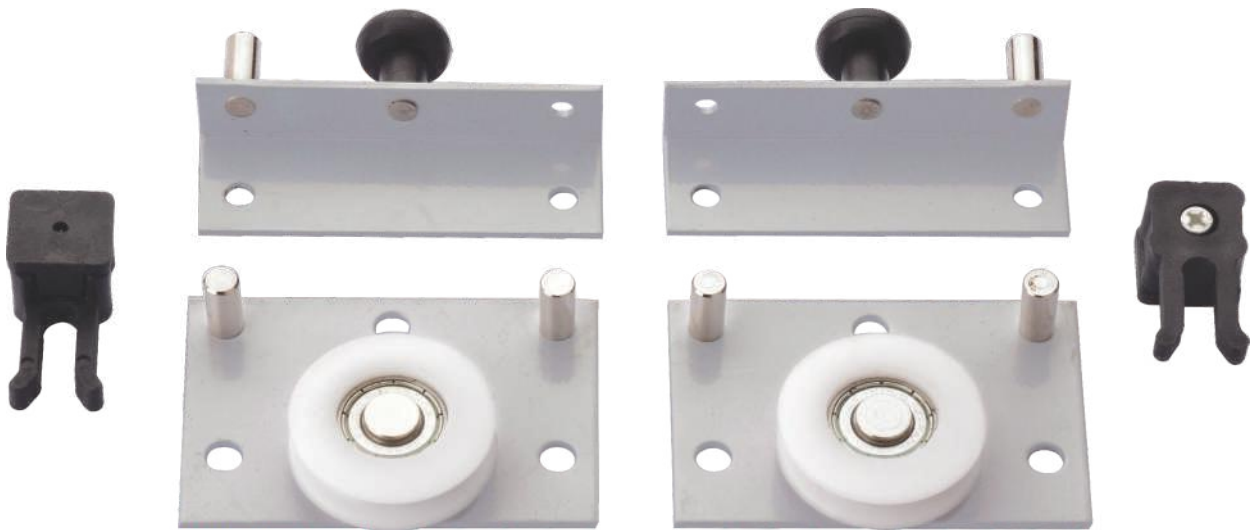

Code : 9070
Material : Mild Steel and Darlin Parts
Finish : Silver Coated
Load Capacity : 40kg
Door Thickness : 18mm
Packing : Single Door Kit

COMPACT DOOR CHANNEL SYSTEM

**NATURAL
 ALLUMINIUM
 FINISH**



Code : 9069A
Material : Alluminium
Finish : Alluminium
Size : 6.5 Feet, 8 Feet, 10 Feet, 12 Feet, 13 Feet
Weight per feet : 0.210gms

**ANODIZED
 FINISH**



Code : 9069B
Material : Alluminium
Finish : Anodized
Size : 6.5 Feet, 8 Feet, 10 Feet, 12 Feet, 13 Feet
Weight per feet : 0.210gms

SLIDE LINE



Code : 9071
Material : Mild Steel, PVC parts
Finish : Grey
Load Capacity : 25kg
Door Thickness : 18mm
Packing : Single Door Kit

SLIDING DOOR SYSTEM SLIDE LINE SYSTEM CHANNEL



**NATURAL
ALLUMINIUM
FINISH**

Code : 9072A
Material : Alluminium
Finish : Alluminium
Size : 8 Feet, 12 Feet
Weight per feet : 0.040gms



**ANODIZED
FINISH**

Code : 9072B
Material : Alluminium
Finish : Anodized
Size : 8 Feet, 12 Feet
Weight per feet : 0.040gms

MILD STEEL



Code : 9073

Finish : Stone Grey

Size : 3 Step,
4Step,
5 Step,
6 Step

Material : Mild Steel

Capacity : 150kg



INDEX

TOPICS	PAGE
Kitchen Fittings :	51 - 62
Tandem Regular / Tandem Slim / Organisers / Soft Close Tall Unit & Snake Basket / Soft Close Pantry Unit & Magic Corner / Tall Units Normal / Stainless Steel Accessories	
Gas Spring	63 - 64
Door Soft Closing System	65
Auto Hinges	66 - 69
Telescopic Slide & Bed Channels	70 - 71
Kitchen Profile Shutters & Handles	72 - 73
Alluminium Handles	74 - 75
Door Holder & Shelves Holder :	76
Door Closer	77

REGULAR



- Code** : 9074
- Material** : Cold rolled steel
- Finish** : Grey
- Open-close test** : 1,00,000 times
- Max. Weight** : 45kg/20"
- Sizes Available** : 20", 22"
- Gallery** : Rectangle
- Features** : High quality cold rolled steel
Hi-Tech electroplating technology for rust resistance
- Application** : Office furniture, kitchen cabinet and home furniture drawer
- Packing** : 6 sets per box

SLIM

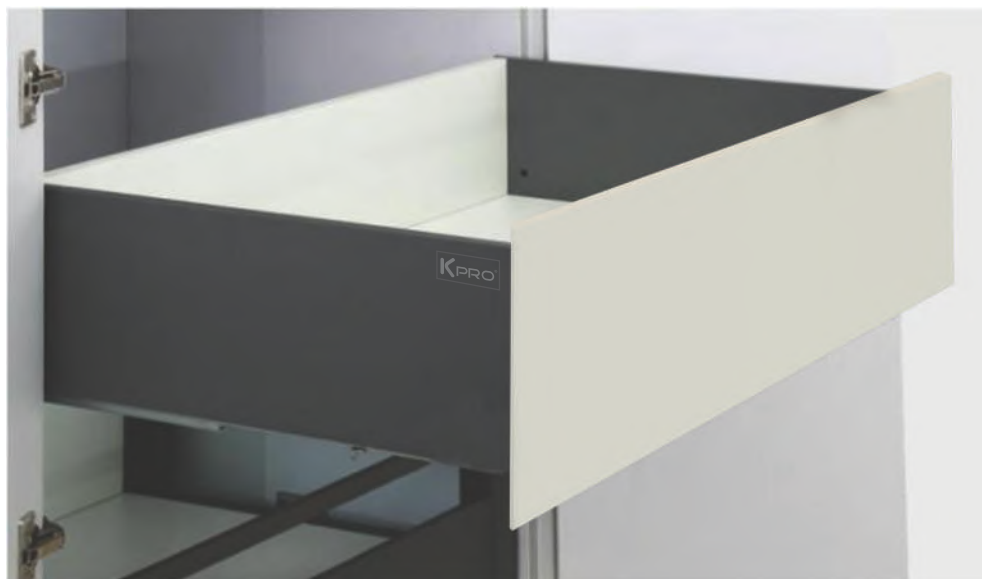

Code	: 9075
Material	: Cold rolled steel
Finish	: Stone Grey
Open-close test	: 1,00,000 times
Max. Weight	: 45kg/20"
Sizes Available	: 20", 22"
Gallery	: Rectangle
Features	: High quality cold rolled steel Hi-Tech electroplating technology for rust resistance
Application	: Office furniture, kitchen cabinet and home furniture drawer
Packing	: 6 sets per box

WOODEN ORGANISERS

Code : 9076

WOODEN ORGANISERS

Available in 600mm & 900mm



Code : 9077

WOODEN PARTAGE

Available in 600mm & 900mm



Code : 9078

WOODEN ADJUSTABLE PARTAGE

Available in 600mm



B4 CUTLERY ORGANISER

Code : 9079

CUTLERY ORGANISER

376 X 475 X 65mm (wxdxh)



ALUMINIUM CUTLERY INSERTS

Code : 9080

329 X 470 FOR 450mm cabinet



Code : 9081

479 X 470 FOR 600mm cabinet



Code : 9082

779 X 470 FOR 600mm cabinet



Code : 9083
PLATE HOLDER



Code : 9084
CUP SAUCER HOLDER



Code : 9085
THALI HOLDER



Size Available : Width-Wise - 450mm, 500mm, 600mm, 900mm Depth-wise - 500mm

EXECUTIVE CUTLERY TRAY

Code : 9086
EXECUTIVE CUTLERY TRAY (45*55)
400 X 500 X 60 (wxdxh)



Code : 9087
EXECUTIVE CUTLERY TRAY (55*55)
550 X 490 X 60mm (wxdxh)



Code : 9088
EXECUTIVE CUTLERY TRAY (50*55)
430 X 500 X 60mm (wxdxh)



Code : 9089
EXECUTIVE CUTLERY TRAY (90*55)
830 X 500 X 60mm (wxdxh)



Tall Unit



Snake Basket



Code : 9090
Description : Soft Close Function
 6 Trays, New Designer
 Stainless Steel Basket
 Adjustment at every 3"
 Special fitting for basket
 Dotted finish anti skid
 Stainless Steel base
Product Dimension : 14" x 19" x (6' - 7')
Cabinet Dimension : 15" x 20" x (6' - 7')
Door Width : 15"
Load Carrying
Capacity : 80kg

Code : 9091
Description : Soft Close Function
 Easy to Install
 White Colour
 Anti Skid Base
 Full Tray Access
Product Dimension : 35" x 20" x 26" - 30"
Cabinet Dimension : 36" - 40"
Door Width : 18"
Load Carrying
Capacity : 20kg

Pantry Unit



Magic Corner



Code : 9092
Description : New Designer Baskets
 Opening angle 135)-150)
 Adjustment at every 3"
 Basket with inbuilt
 Special fitting for basket
 Dotted finish anti skid
 Stainless Steel base
Product Dimension: 17" x 20" x (6' - 7')
Cabinet Dimension: 18" x 20"
Door Width : 18"
Load Carrying
Capacity : 80kg

Code : 9093
Description : Soft Close Function
 New Designer SS Basket
 Dotted Finished
 Anti Skid SS Base
 Wider Baskets
Product Dimension: 35" - 39" x 20" x 21"
Cabinet Dimension: 36" - 40"
Door Width : 18"
Load Carrying
Capacity : 20kg

TALL UNITS

(304 / 202)



Code : 9094

Features :

- Heavy duty bottom channel
- 90 degree rotation for easy operation
- Adjustable height between 6' to 7'
- Easy Installation
- Shelves adjustable at every 3"
- Size also available between 4' to 5'

W x D x H

15" x 20" x 6' to 7'

For fitment in carcass

25 mm space request



Code : 9095

Features :

- Heavy duty bottom channel
- 90 degree rotation for easy operation
- Adjustable height between 6' to 7'
- Easy Installation
- Shelves adjustable at every 3"
- Size also available between 4' to 5'

W x D x H

10" x 20" x 6' to 7'

12" x 20" x 6' to 7'

15" x 20" x 6' to 7'

For fitment in carcass

25 mm space required



Code : 9096

Unit with 12 basket left / right side

Unit with 18 basket left / right side

Unit with 36 basket left / right side

INSIDE CABINET DIMENSION

	W (A)	D (B)	H (C)
12 basket	17"	24"	68" - 79"
18 basket	17"	24"	68" - 79"
36 basket	35"	24"	68" - 79"

Product Dimension: 15" x 19" x 68" - 79"

GLORY UNIT



Code : 9097

Product Dimension - W 15" X D 19" X H 20"
Inside Cabinet Dimension - W 16" X 20" X H 24"

SNAKE BASKET



Code : 9098

Product Dimension - W 33" X D 19.5" X H 20"
Inside Cabinet Dimension - W 34" X D 20" X H 24"

MAGIC CORNER LEFT/RIGHT



Code : 9099

Product Dimension - W 32"- 36" X D 20" X H 27"
Inside Cabinet Dimension - W 32" X D 17.5" X H 20"

PLATFORM CORNER CAROUSEL S.S.



Code : 9100

Diameter :
13" X 3" Shelves
Height : Pipe 48"
Shelves can be adjustable at each 3" gap

CAROUSEL S.S.



Code : 9101

18", 20", 22", 24", 27", & 30" Diameter
Set of 2 Trays with fitting kit
29" Pipe

"D" TRAY S.S.

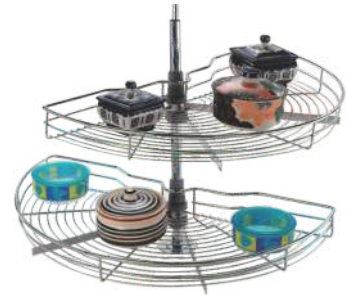

Code : 9102

18", 20", 22", 24", 27", & 30" Diameter
Set of 2 Trays with fitting kit
29" Pipe

HANGING THREE TIER CORNER SHELF



Code : 9103

L 11.93" X W 11.93" X H 27.95"

HANGING TWO TIER CORNER SHELF



Code : 9104

W 12" X D 12" X H 20"

DESIGNER MULTIPURPOSE RACK TWO TIER SQUARE TYPE. WITH FRAME



Code : 9105

L 13.98" X W 4.92" X H 12.99"

HANGING MULTI PURPOSE RACK SINGLE S.S.



Code : 9106

W 14" X D 5" X H 10.5"

HANGING CORNER SINGLE S.S.



Code : 9107

W 12" X H 3.5" (89)
W 15" X H 3.5" (146)

HANGING MULTI PURPOSE RACK DOUBLE S.S.



Code : 9108

W 14" X D 5" X H 17"

**2 TIER MULTIPURPOSE
BIG RACK**



Code : 9109

W 16.53" X D 5.7" X H 12.99"

**HANGING CORNER
SINGLE DELUX S.S.**



Code : 9110

W 13" X H 8"

**DESIGNER CORNER TWO
TIER WITH FRAME**



Code : 9111

L 11.93" X W 11.93" X H 15.47"

**DESIGNER MULTIPURPOSE
RACK THREE TIER
SQUARE TYPE.**



Code : 9112

L 13.98" X W 4.92" X H 22.95"

**2 TIER MULTIPURPOSE
SMALL RACK**



Code : 9113

L 8.66" X W 5.71" X H 12.99"

**2 TIER MULTI PURPOSE RACK
WITH FRAME**



Code : 9114

L 13.97" X W 5.90" X H 16.92"

HANGING UTILITY



Code : 9115

W 13.8" X D 20.3" X H 17"

**ALL PURPOSE
BATHROOM HANGING**



Code : 9116

W 10.8" X D 15" X H 22.8"

DRAINER RACK



Code : 9117

W 12" X D 20.4" X H 17.1"

MULTI PURPOSE RACK FOR BOTTLE HOLDER



Code : 9118

L 13.97" X W 5.9" X H 16.92"

DESIGNER 2 TIER MULTI PURPOSE RACK WITH FRAME



Code : 9119

L 13.97" X W 5.23" X H 16.92"

PERFORATED DUSTBIN



Code : 9120

Regular type	Paddle Type
07" X 10"	08" X 11"
09" X 12"	09" X 12"
10" X 14"	10" X 15"

DUSTBIN S.S.



Code : 9121

Height : 11.5"
Diameter : 9"

BIN HOLDER S.S.



Code : 9122

Height : 5.5"
Diameter : 10.25"

NAPKIN HOLDER



Code : 9123

L 17.91" X W 9.92" X H 6.50"

DETERGENT HOLDER S.S.



Code : 9124

W 15.5" X D 8" X H 9"

SHOWER CADDY



Code : 9125

W X D X H
9" X 5.5" X 20"

TOWEL HOLDER SINGLE TIER



Code : 9126

W 16.53" X D 5.7" X H 1.58"

LAUNDRY BASKET



Code : 9127

W 14.5" X D 15" X H 16.5"

STORAGE RACK PERFUME HOLDER



Code : 9128

W 12.20" X D 4.33" X H 4"

RIGHT RACK S.S.



Code : 9129

W 12" X D 5" X H 5.25"
W 15" X D 5" X H 5.25"

CORNER S.S.



Code : 9130

12" (61) 15"

HALF ROUND MULTIPURPOSE RACK



Code : 9131

L 14.96" X W 12.20" X H 12.20"

MAGAZINE STAND S.S. (69)



Code : 9132

W 12" X D 5.5" X H 11"

PLATE COASTER S.S. (44)



Code : 9133

W 8" X H 12"

DRAWER CHANNEL FITTING KIT S.S.

(Patent Registered)*

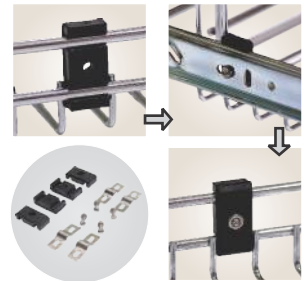

Code : 9134

TROUSER / SAREE SLIDER (Regular)



Code : 9135

L 12" X W 14" X H 6"
L 15" X W 14" X H 6"
L 18" X W 14" X H 6"
L 20" X W 14" X H 6"

TROUSER RACK



Code : 9136

W 31.5" X D 18" X H 4"

SLIDING HANGER HOLDER



Code : 9137

W 1" X L 12" X H 6"
W 1" X L 15" X H 6"
W 1" X L 18" X H 6"
W 1" X L 20" X H 6"

BIG UTENSIL BASKET / WARDROBE BASKET / PULL OUT BASKET S.S.

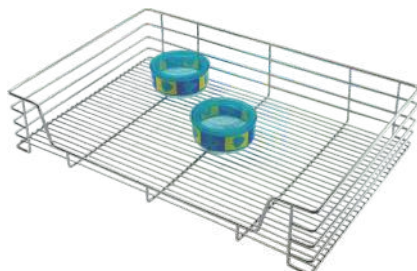

Code : 9138

W X D X H
28" X 20" x 4" - 6" - 8"
32" X 20" x 4" - 6" - 8"
35" X 20" x 4" - 6" - 8"

SHOES RACK



Code : 9139

W 32" X D 19.6" X H 3.93"
W 32" X D 16" X H 3.93"

CLOTH DRYER STAND
FOLDING TYPE



UNFOLD

Folded condition:
W 3" x D 26" H 48"

Code : 9140



Unfolded condition:
W 33" x D 24" H 46"

FOLDED

TROLLEY



Code : 9141

W 19" X D 20" X H 36"

WINE GLASS HOLDER



Code : 9142

Single		Double	
L	H X W	L	H X W
12"	X 2" X 6"	12"	X 2" X 12"
15"	X 2" X 6"	15"	X 2" X 12"
18"	X 2" X 6"	15"	X 2" X 13"

GAS TROLLEY S.S.



Code : 9143

W 11" X H 4"

GLASS TRAY / PLATE TRAY S.S.



Code : 9144

W X D

20" X 10.5"	28" X 10.5"
22" X 10.5"	30" X 10.5"
24" X 10.5"	32" X 10.5"

PUSH/PULL STICKER



Code : 9145

GAS SPRINGS 9" (WITH SOFT CLOSING)

Code : 9146
Material : Mild Steel and PVC parts
Finish : Silver
Load Capacity : 5kg, 10kg, 15kg

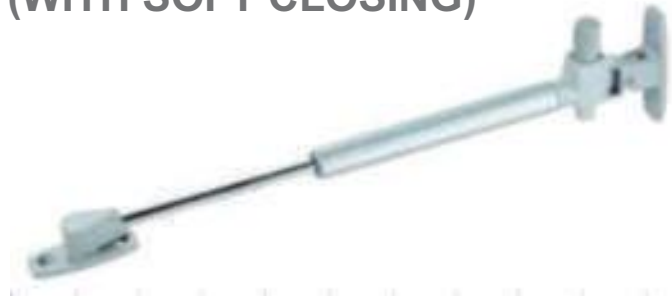

GAS SPRINGS 9"



Code : 9147
Material : Mild Steel and PVC parts
Finish : Black
Load Capacity : 5kg, 10kg, 15kg, 20kg, 25kg

GAS SPRINGS 12" (15MM X 6MM)



Code : 9148
Material : Mild Steel and PVC parts
Finish : Black
Load Capacity : 5kg, 10kg, 15kg, 20kg, 25kg

GAS SPRINGS 12" (15MM X 6MM)

(LIGHT)



Code : 9149
Material : Mild Steel
Finish : Black
Load Capacity : 5kg, 10kg, 15kg, 20kg, 25kg, 30kg & 35kg

GAS SPRINGS 12" (18MM X 8MM) (HEAVY)



Code : 9150
Material : Mild Steel
Finish : Black
Load Capacity : 5kg, 10kg, 15kg, 20kg, 25kg, 30kg, 35kg, 50kg,

GAS SPRINGS 15" (18MM X 8MM)



Code : 9151
Material : Mild Steel
Finish : Black
Load Capacity : 10kg, 15kg, 20kg, 25kg, 30kg, 35kg, 50kg

GAS SPRINGS 18" (22MM X 10MM)



Code : 9152
Material : Mild Steel
Finish : Black
Load Capacity : 50kg, 75kg, 100kg, 125kg, 150kg

GAS SPRINGS 24" (22MM X 10MM)



Code : 9153
Material : Mild Steel
Finish : Black
Load Capacity : 50kg, 75kg, 100kg, 125kg, 150kg

UP & OVER LIFT SYSTEM



Code : 9154

Material : Mild Steel, PVC part

Finish : Silver

UP & TURNING LIFT SYSTEM



Code : 9155

Material : Mild Steel, PVC part

Finish : Silver

UP & TURNING LIFT SYSTEM



Code : 9156

Material : Mild Steel, PVC part

Finish : Silver

UP & TURNING LIFT SYSTEM



Code : 9157

Material : Mild Steel, PVC part

Finish : Silver

(NORMAL)



0°

Code : 9158
 Material : MS
 Finish : Nickle Plated



45°

Code : 9162
 Material : MS
 Finish : Nickle Plated



8°

Code : 9159
 Material : MS
 Finish : Nickle Plated



90°

Code : 9163
 Material : MS
 Finish : Nickle Plated



15°

Code : 9160
 Material : MS
 Finish : Nickle Plated



135°

Code : 9164
 Material : MS
 Finish : Nickle Plated



30°

Code : 9161
 Material : MS
 Finish : Nickle Plated



165°

Code : 9165
 Material : MS
 Finish : Nickle Plated

MS HYDRAULIC HINGE



HYDRAULIC BOOSTER ARM



SEE CLEAR LOGO

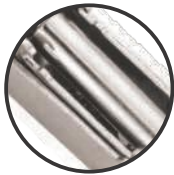

HYDRAULIC CYLINDER



ADJUSTMENT SCREW



Code : 9166

Description: 0°, 8°, 15°

Material : Soft Closing (MS)

Finish : Nickle Plated

SS HYDRAULIC HINGE



HYDRAULIC BOOSTER ARM



SEE CLEAR LOGO

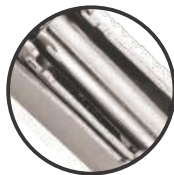

HYDRAULIC CYLINDER



ADJUSTMENT SCREW



Code : 9167

Description: 0°, 8°, 15°

Material : Soft Closing (SS)

Finish : Nickle Plated

3D HYDRAULIC HINGE

BLANK DESIGN
THE DOOR IS MORE SECURE AND RELIABLE

ADJUSTING HINGES BASE

BASE ADJUSTMENT UP/DOWN :±2MM

ADJUSTING THE DOOR FRONT/BACK

THE SIZE OF THE GAP IS REGULATED BY SCREWS

TWO LAYER PLATING

SMOOTH AND BRIGHT SURFACE STRONG RUST RESISTANCE

BOLD SPRING

LONG LASTING HYDRAULIC PRESSURE, NOT EASY TO BREAK

ADJUSTING COVER OF DOOR

LEFT/RIGHT DEVIATION SCREWS ADJUST 0-5MM



Code : 9168

Description: 0°, 8°, 15°

Material : Soft Closing (3D)

Finish : Nickle Plated

(3D SOFT CLOSING) PLATINIUM

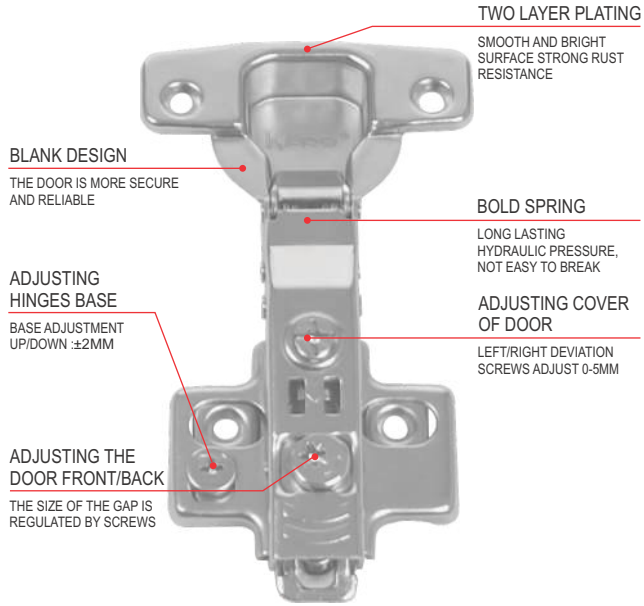

NEUMETRIC HYDRAULIC CYLINDER

Code : 9169
 Description: 0°, 8°, 15°
 Material : Soft Closing (3D)
 Finish : Nickle Plated

(NORMAL HINGE) PLATINIUM

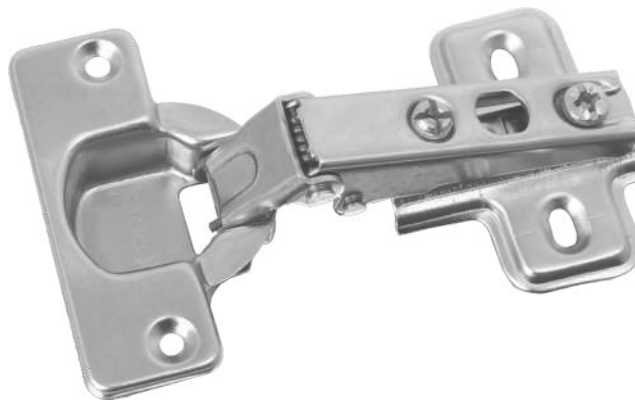

Code : 9170
 Description: 0°, 8°, 15°
 Material : Normal
 Finish : Nickle Plated

THICK DOOR HINGES



Code : 9171

Description : 0°, 8°, 15°

Material : Thick Door Soft Closing-MS (40mm)

Finish : Nickle Plated

GLASS HINGES



Code : 9172

Description : 0°, 8°, 15°

Material : Glass Soft Closing (MS)

Finish : Nickle Plated

PROFILE HINGES

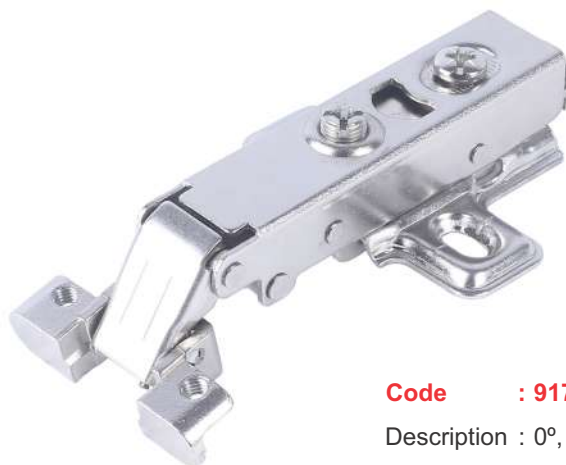

Code : 9173

Description : 0°, 8°, 15°

Material : Soft Closing Profile Hanges (MS)

Finish : Nickle Plated

(56gms)



Code : 9174

Material : Mild Steel and Nylon parts

Finish : Epoxy Black / Zinc with Electro Plated

Load Capacity : 22kg

Sizes Available : 10", 12", 14", 16", 18", 20", 22", 24"

(70gms)



Code : 9175

Material : Mild Steel and Nylon parts

Finish : Epoxy Black / Zinc with Electro Plated

Load Capacity : 30kg

Sizes Available : 10", 12", 14", 16", 18", 20", 22", 24"

SOFT CLOSE SLIDE



Code : 9176
Material : Mild Steel
Finish : Zinc
Load Capacity : 30kg
Size : 20", 22"

BED CHANNEL



Code : 9177
Material : Mild Steel
Finish : Zinc
Size : 12", 14", 16", 18", 20"
22", 24", 26", 28", 30"
32", 34", 36", 42", 48"



(ALLUMINIUM)

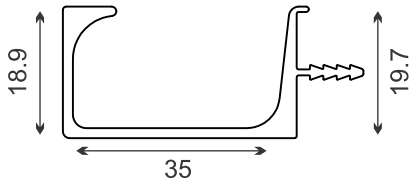

Code : 9178

Material : Alu. Handle Profile
 Size : Width - 35mm (Size-3mtr.) G-TYPE
 Finish : Alu., Brush C P, SS Matt, Crome, Rose Gold, Sapphire Grey, Bronze Gold
 Packing : 10pc.

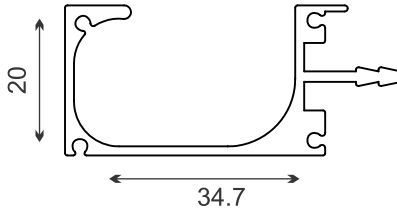

Code : 9179

Material : Alu. Handle Profile
 Size : Width-35mm (Size-3mtr.) G-HOLE TYPE
 Finish : Alu., SS Matt
 Packing : 10pc.

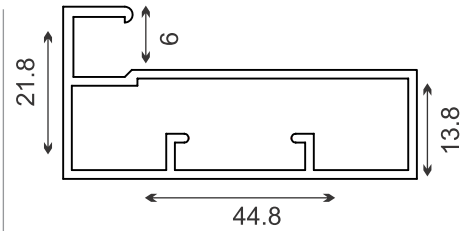

Code : 9180

Material : Alu. Shutter Profile
 Size : Width - 45mm (Size-3mtr.) Including with Gasket for 4mm Glass Front View - 9mm
 Finish : Alu., Brush C P, SS Matt, Crome, Rose Gold, Sapphire Grey, Bronze Gold
 Packing : 10pc.

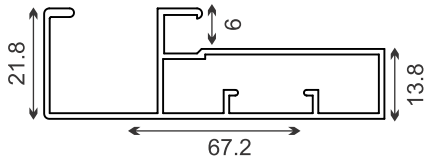

Code : 9181

Material : Alu. Shutter Profile
 Size : Width - 68mm V-004 One Side Only Other 3 sides require V-003 (Size-3mtr.) Inclusive with Gasket for 4mm glass Front View - 9mm
 Finish : Alu., Brush C P, SS Matt, Crome, Rose Gold, Sapphire Grey, Bronze Gold
 Packing : 10pc.

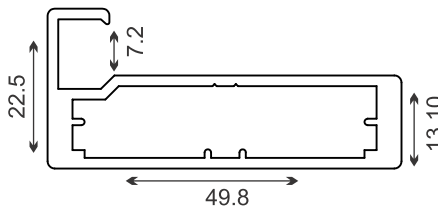

Code : 9182

Material : Alu. Shutter Profile
 Size : Width - 50mm (Size-3mtr.) Including with Gasket for 6mm Glass Front View - 9mm
 Finish : Alu., Brush C P, SS Matt, Crome
 Packing : 10pc.

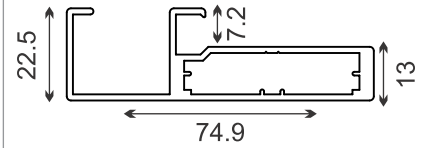

Code : 9183

Material : Alu. Shutter Handle Profile
 Size : Width - 75mm V-006 One Side Only Other 3 sides require V-005 (Size-3mtr.) Inclusive with Gasket for 6mm glass Front View - 8mm
 Finish : Alu., Brush C P, SS Matt, Crome
 Packing : 10pc.

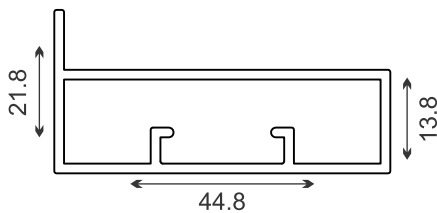

Code : 9184

Material : Alu. Shutter Profile
 Size : Width - 45mm (Size-3mtr.) Glass Stick Shutter Profile Glass Stick Thickness - 4&5 mm Front View - 1mm
 Finish : Alu., Brush C P, SS Matt, Crome
 Packing : 10pc.

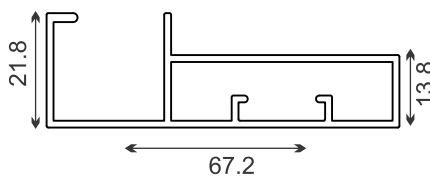

Code : 9185

Material : Alu. Shutter Handle Profile
 Size : Width - 67mm (Size-3mtr.) V-008 One Side Only Other 3 sides require V-007 Glass Stick Shutter Profile Glass Thickness - 4&5 mm Front View - 1mm
 Finish : Alu., Brush C P, SS Matt, Crome
 Packing : 10pc.

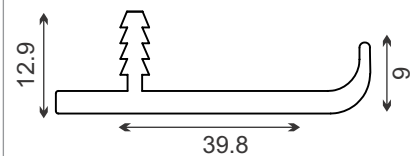

Code : 9186

Material : Alu. Edge Handle Profile
 Size : Width - 40mm (Size-3mtr.) (J-Type)
 Finish : Alu., Brush C P, SS Matt, Crome, Rose Gold, Sapphire Grey, Bronze Gold
 Packing : 10pc.

KITCHEN PROFILE SHUTTERS & HANDLES



(ALLUMINIUM)

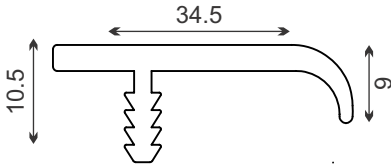

Code : 9187

Material : Alu. Edge Handle Profile
 Size : Width - 34.5mm (Size-3mtr.) (J-Type)
 Finish : Alu., Brush C P, SS Matt, Crome, Rose Gold, Sapphire Grey, Bronze Gold
 Packing : 10pc.

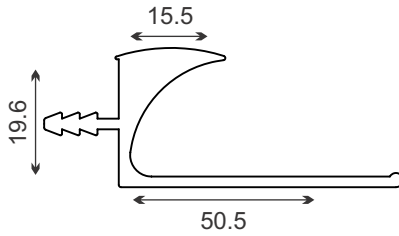

Code : 9188

Material : Alu. Edge Handle Profile
 Size : Height - 50mm (Size-3mtr.) (J-Type)
 Finish : Alu., Brush C P, SS Matt, Crome, Rose Gold, Sapphire Grey, Bronze Gold
 Packing : 10pc.

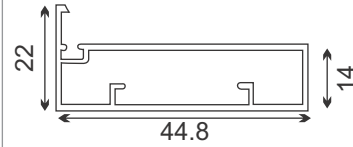

Code : 9189

Material : Alu. Shutter Profile
 Size : Width - 45mm (Size-3mtr.) Inclusive with Gasket for 4&5 mm Glass Front View - 3.5 mm
 Finish : Alu., SS Matt, Crome
 Packing : 10pc.

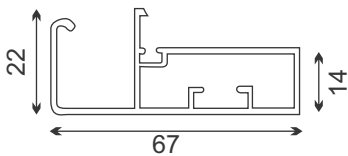

Code : 9190

Material : Alu. Shutter Handle Profile
 Size : Width - 67mm (Size-3mtr.) V-016 One Side Only Other 3 side require V-015 (Size-3mtr.) Inclusive with Gasket for 4&5 mm Glass Front View - 3.5 mm
 Finish : Alu., SS Matt, Crome
 Packing : 10pc.

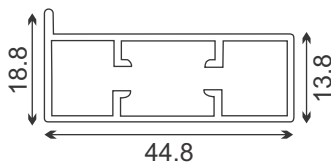

Code : 9191

Material : Alu. Shutter Profile
 Size : Width - 45mm (Size-3mtr.) Glass Stick Shutter Profile Glass Stick Thickness - 4&5 mm Front View - 1 mm
 Finish : Alu., Brush C P, SS Matt, Crome
 Packing : 10pc.

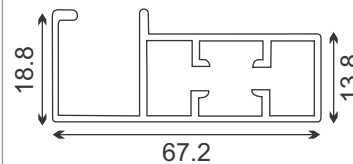

Code : 9192

Material : Alu. Shutter Handle Profile
 Size : Width - 67mm (Size-3mtr.) V-018 One Side Only Other 3 sides require V-017 Glass Stick Shutter Profile Glass Stick Thickness - 4&5 mm Front View - 1 mm
 Finish : Alu., Brush C P, SS Matt, Crome
 Packing : 10pc.



Code : 9193

Material : L-Profile Connector
 Finish : Zinc
 Packing : 100pc.



Code : 9194

Material : Finish Profile Connector
 Finish : Zinc
 Packing : 100pc.



Code : 9195

Material : Aluminium

Finish : Silver Anodised, SS Matt, Chrome, Rose Gold, Shappire Grey, Matt Black

Size : 200mm, 250mm, 300mm, 350mm, 400mm, 450mm, 500mm, 550mm, 600mm, 650mm, 700mm, 750mm, 800mm, 850mm, 900mm

Packing : 20pc.



Code : 9196

Material : Aluminium

Finish : Silver Anodised, SS Matt, Chrome, Rose Gold, Shappire Grey, Matt Black

Size : 200mm, 250mm, 300mm, 350mm, 400mm, 450mm, 500mm, 550mm, 600mm, 650mm, 700mm, 750mm, 800mm, 850mm, 900mm

Packing : 20pc.



Code : 9197

Material : Aluminium

Finish : Silver Anodised, SS Matt, Chrome, Rose Gold, Shappire Grey, Matt Black

Size : 200mm, 250mm, 300mm, 350mm, 400mm, 450mm, 500mm, 550mm, 600mm, 650mm, 700mm, 750mm, 800mm, 850mm, 900mm

Packing : 20pc.



Code : 9198

Material : Aluminium

Finish : Silver Anodised, SS Matt, Chrome, Rose Gold, Shappire Grey, Matt Black

Size : 200mm, 250mm, 300mm, 350mm, 400mm, 450mm, 500mm, 550mm, 600mm, 650mm, 700mm, 750mm, 800mm, 850mm, 900mm

Packing : 20pc.



Code : 9199

Material : Aluminium

Finish : Silver Anodised, SS Matt, Chrome, Rose Gold, Shappire Grey, Matt Black

Size : 200mm, 250mm, 300mm, 350mm, 400mm, 450mm, 500mm, 550mm, 600mm, 650mm, 700mm, 750mm, 800mm, 850mm, 900mm

Packing : 20pc.



Code : 9200

Material : Aluminium

Finish : Silver Anodised, SS Matt, Chrome, Rose Gold, Shappire Grey, Matt Black

Size : 200mm, 250mm, 300mm, 350mm, 400mm, 450mm, 500mm, 550mm, 600mm, 650mm, 700mm, 750mm, 800mm, 850mm, 900mm

Packing : 20pc.



Code : 9201

Material : Aluminium

Finish : Silver Anodised, SS Matt, Chrome, Rose Gold, Shappire Grey, Matt Black

Size : 200mm, 250mm, 300mm, 350mm, 400mm, 450mm, 500mm, 550mm, 600mm, 650mm, 700mm, 750mm, 800mm, 850mm, 900mm

Packing : 20pc.

ALLUMINIUM HANDLES



Code : 9202

Material : Aluminium

Finish : Silver Anodised, SS Matt, Chrome, Rose Gold, Shappire Grey, Matt Black

Size : 200mm, 250mm, 300mm, 350mm, 400mm, 450mm, 500mm, 550mm, 600mm, 650mm, 700mm, 750mm, 800mm, 850mm, 900mm

Packing : 20pc.



Code : 9203

Material : Aluminium

Finish : Silver Anodised, SS Matt, Chrome, Rose Gold, Shappire Grey, Matt Black

Size : 200mm, 250mm, 300mm, 350mm, 400mm, 450mm, 500mm, 550mm, 600mm, 650mm, 700mm, 750mm, 800mm, 850mm, 900mm

Packing : 20pc.



Code : 9204

Material : Aluminium

Finish : Silver Anodised, SS Matt, Chrome, Rose Gold, Shappire Grey, Matt Black

Size : 200mm, 250mm, 300mm, 350mm, 400mm, 450mm, 500mm, 550mm, 600mm, 650mm, 700mm, 750mm, 800mm, 850mm, 900mm

Packing : 20pc.

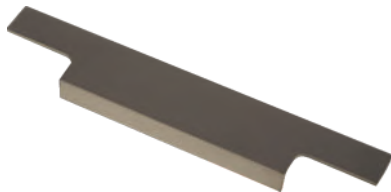

Code : 9205

Material : Aluminium

Finish : Silver Anodised, SS Matt, Chrome, Rose Gold, Shappire Grey, Matt Black

Size : 200mm, 250mm, 300mm, 350mm, 400mm, 450mm, 500mm, 550mm, 600mm, 650mm, 700mm, 750mm, 800mm, 850mm, 900mm

Packing : 20pc.



Code : 9206

Material : Aluminium

Finish : Silver Anodised, SS Matt, Chrome, Rose Gold, Shappire Grey, Matt Black

Size : 200mm, 250mm, 300mm, 350mm, 400mm, 450mm, 500mm, 550mm, 600mm, 650mm, 700mm, 750mm, 800mm, 850mm, 900mm

Packing : 20pc.

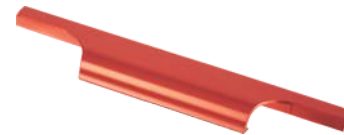

Code : 9207

Material : Aluminium

Finish : Silver Anodised, SS Matt, Chrome, Rose Gold, Shappire Grey, Matt Black

Size : 200mm, 250mm, 300mm, 350mm, 400mm, 450mm, 500mm, 550mm, 600mm, 650mm, 700mm, 750mm, 800mm, 850mm, 900mm

Packing : 20pc.



Code : 9208

Material : Aluminium

Finish : Silver Anodised, SS Matt, Chrome, Rose Gold, Shappire Grey, Matt Black

Size : 200mm, 250mm, 300mm, 350mm, 400mm, 450mm, 500mm, 550mm, 600mm, 650mm, 700mm, 750mm, 800mm, 850mm, 900mm

Packing : 20pc.



Code : 9209

Material : Aluminium

Finish : Silver Anodised, SS Matt, Chrome, Rose Gold, Shappire Grey, Matt Black

Size : 200mm, 250mm, 300mm, 350mm, 400mm, 450mm, 500mm, 550mm, 600mm, 650mm, 700mm, 750mm, 800mm, 850mm, 900mm

Packing : 20pc.



Code : 9210

Material : Aluminium

Finish : Silver Anodised, SS Matt, Chrome, Rose Gold, Shappire Grey, Matt Black

Size : 200mm, 250mm, 300mm, 350mm, 400mm, 450mm, 500mm, 550mm, 600mm, 650mm, 700mm, 750mm, 800mm, 850mm, 900mm

Packing : 20pc.



Code : 9211
 Description : Bell Magnet (Small)
 Material : Stainless Steel
 Finish : Brush Steel



Code : 9212
 Description : Bell Magnet (Big)
 Material : Stainless Steel
 Finish : Brush Steel

SHELVES HOLDER



Code : 9213
 Description : Shelf Holder
 Material : Brass
 Finish : Chrome



Code : 9214
 Description : Shelf Holder
 Material : Brass
 Finish : Chrome



Code : 9215
 Description : Shelf Holder
 Material : Zinc Alloy
 Finish : Chrome



Code : 9216
 Description : Shelf Holder
 Material : Zinc Alloy
 Finish : Chrome



Code : 9217
Material : Aluminium
Finish : Silver Anodised
Load Capacity : 60kg



Code : 9218
Material : Aluminium
Finish : Silver Anodised
Load Capacity : 70kg to 80kg



Code : 9219
Material : Aluminium
Finish : Silver Anodised
Load Capacity : 100kg

Palmet Door Closer



Code : 9220
Material : Aluminium
Finish : Silver Anodised
Load Capacity : 100kg

Conceal Door Closer



Code : 9221
Material : Aluminium
Finish : Silver Anodised
Load Capacity : 80kg



INDEX

TOPICS

PAGE

Glass Fittings :	78 - 96
Floor Spring / Combo Set / Patch Fittings / Glass Connector / Shower Glass Door Knob / Glass Connector / Shower Hinge (304) / Glass Sealing Profile / Shower Headers / Shower Glass Door Handles / Shower Hinge (Zinc) / Spider Fittings, Routel, Splice Plate & Fin Plate / Canopy Fittings / Shower Glass Sliding System / Glass Sliding Fitting & Channel / Sliding Glass Door Handle / Glass Door Locks / Point Glass Fittings / Mortise Handle / Glass Door Handle	
Baluster & Spigot Railing	97 - 100

FLOOR SPRING



Code : 9222
 Description : Single Cylinder Floor Spring
 60-90 kg Weight Capacity
 Finish : Matt / Glossy



Code : 9223
 Description : Double Cylinder Floor Spring
 90-120 Kg Weight Capacity
 Finish : Matt / Glossy



Code : 9224
 Description : Double Cylinder Floor Spring
 up to 150 Kg Weight Capacity
 Finish : Matt / Glossy



Code : 9225
 Description : Fitting Accessories for
 Aluminium and Wooden Door
 Finish : Matt



COMBO SET



Code : 9226
 Description : Weight Capacity up to 90kg
 Cover Plate (SS)
 Without Accessories
 Dimension of appearance 250 x 110 x 50
 max. door width 900 mm
 Finish : SS Matt (304)
 Packing : 4pc.

TOP PATCH
 Fit to Glass thickness 10mm to 12mm
 Material Aluminium

BOTTOM PATCH
 Fit to Glass thickness 10mm to 12mm
 Material Aluminium

OVER TOP PIVOT

GLASS FITTINGS

PATCH FITTING - STAINLESS STEEL S.S. 304



Code : 9227
Description : Top Patch Fitting
Finish : Matt / Glossy



Code : 9228
Description : Bottom Patch Fitting
Finish : Matt / Glossy



Code : 9229
Description : Bottom Patch Lock
Finish : Matt / Glossy



Code : 9230
Description : Strike Box
Finish : Matt / Glossy



Code : 9231
Description : Side over panel
Patch with Plate
Finish : Matt / Glossy



Code : 9232
Description : Over Panel corner
patch - small
Finish : Matt / Glossy



Code : 9233
Description : Over Panel Corner
Patch - Big L
Finish : Matt / Glossy



Code : 9234
Description : Top Patch Pivot
Finish : Matt / Glossy



Code : 9235
Description : Over Panel Side
Panel with Pivot-Left
Finish : Matt / Glossy

PATCH FITTING - STAINLESS STEEL S.S. 304



Code : 9236
 Description : Over Panel Side Panel with Pivot-Right
 Finish : Matt / Glossy



Code : 9237
 Description : Over Panel Side Panel with Pivot for Double Door
 Finish : Matt / Glossy



Code : 9238
 Description : Bottom Bearing Patch Pivot
 Finish : Matt / Glossy



Code : 9239
 Description : Patch Connector
 Finish : Matt / Glossy



Code : 9240
 Description : Tow Glass Patch Connector (Fit For Wall Side)
 Finish : Matt / Glossy



Code : 9241
 Description : Glass to Glass Patch Connector (Fit for Middle Side)
 Finish : Matt / Glossy

GLASS CONNECTOR - STAINLESS STEEL 304



Code : 9242
 Description : Four Glass Patch Connector
 Finish : Matt / Glossy



Code : 9243
 Description : Fix Clip Connector (Double Hole)
 Finish : Matt / Glossy



Code : 9244
 Description : Fix Clip Connector (Single Hole)
 Finish : Matt / Glossy



Code : 9245
 Description : Wall to Glass 900 Connector
 Finish : Matt / Glossy

GLASS FITTINGS



GLASS CONNECTOR SHEET METALS - STAINLESS STEEL 304



Code : 9246
Description: Glass to Glass 90° Connector
Finish : Matt / Glossy



Code : 9247
Description: Glass to Glass 135° Connector
Finish : Matt / Glossy



Code : 9248
Description: Glass to Glass 180° Connector
Finish : Matt / Glossy



Code : 9249
Description: Wall to Glass 180° Connector
Finish : Matt / Glossy



Code : 9250
Description: Three way 90° Glass to Glass Connector
Finish : Matt / Glossy

SHOWER GLASS DOOR KNOB - BRASS



Code : 9251
Description: Glass Door Knob
Finish : Matt / Glossy



Code : 9252
Description: Glass Door Knob
Finish : Matt / Glossy



Code : 9253
Description: Glass Door Knob
Finish : Matt / Glossy

GLASS CONNECTOR - STAINLESS STEEL 304



Code : 9254
 Description: Glass to Glass 90° Connector
 Finish : Matt / Glossy



Code : 9255
 Description: Glass to Glass 135° Connector
 Finish : Matt / Glossy



Code : 9256
 Description: Glass to Glass 180° Connector
 Finish : Matt / Glossy



Code : 9257
 Description: Wall to Glass 180° Connector
 Finish : Matt / Glossy



Code : 9258
 Description: Three way 90° Glass to Glass Connector
 Finish : Matt / Glossy



GLASS CONNECTOR SHEET METALS - STAINLESS STEEL 304



Code : 9259
 Description: Fix Clip Connector (Double Hole)
 Finish : Matt / Glossy

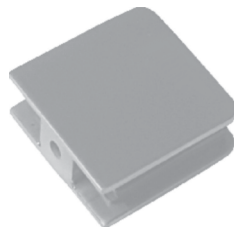

Code : 9260
 Description: Fix Clip Connector (Single Hole)
 Finish : Matt / Glossy



Code : 9261
 Description: Wall to Glass 90° Connector
 Finish : Matt / Glossy

GLASS FITTINGS



SHOWER HINGES - STAINLESS STEEL 304



Code : 9262
Description : Wall to Glass 90°
Finish : Matt / Glossy



Code : 9263
Description : Glass to Glass 180°
Finish : Matt / Glossy



Code : 9264
Description : Glass to Glass 135°
Finish : Matt / Glossy



Code : 9265
Description : Wall to Glass 90°
Finish : Matt / Glossy



Code : 9266
Description : Fixed Clip
Finish : Matt



Code : 9267
Description : Wall to Glass 90°
One Side
Finish : Matt



Code : 9268
Description : Three way Glass to Glass
Hinges
Finish : Matt



GLASS SEALING PROFILE - 2.2 METER LENTGH



Code : 9269
 Description : Glass to Glass 180°
 (H Profile)
 Application : 10 mm / 12 mm



Code : 9270
 Description : Glass to Glass 90°
 (F Profile)
 Application : 10 mm / 12 mm



Code : 9271
 Description : Wall to Glass
 (D Profile)
 Application : 10 mm / 12 mm

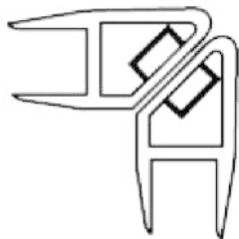

Code : 9272
 Description : Glass to Glass 90°
 (Magnetic Seal)
 Application : 10 mm / 12 mm

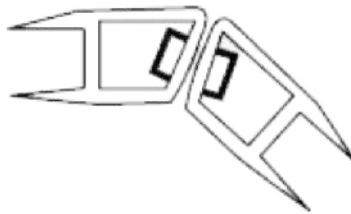

Code : 9273
 Description : Glass to Glass 135°
 (Magnetic Seal)
 Application : 10 mm / 12 mm



Code : 9274
 Description : Glass to Glass 180°
 (Magnetic Seal)
 Application : 10 mm / 12 mm

SHOWER HEADERS - BRASS



Code : 9275
 Description : Pipe to Wall Connector
 (Wall Socket)
 Finish : Matt / Glossy



Code : 9276
 Description : Pipe to Glass Connector
 (Support Clamp)
 Finish : Matt / Glossy



Code : 9277
 Description : Pipe to Glass
 Connector (End Clamp)
 Finish : Matt / Glossy

SHOWER HEADERS - BRASS



Code : 9278

Description: Adjustable Clamp for Two Way Connecting Pipe

Finish : Matt / Glossy



Code : 9279

Description: Support Clamp for Three Way Connecting Pipe

Finish : Matt / Glossy



Code : 9280

Description: 19 mm Round Pipe 2 Meter Length

Finish : Matt / Glossy

SHOWER GLASS DOOR HANDLE - STAINLESS STEEL 304



Code : 9281

Description: Shower Glass Door Handle

Size : 19 x 150 x 400
19 x 150 x 450
19 x 200 x 400
19 x 200 x 450

Finish : Matt / Glossy



Code : 9282

Description: Shower Glass Door Handle

Size : 20 x 150 x 400
20 x 150 x 450
20 x 200 x 400
20 x 200 x 450

Finish : Matt / Glossy

SHOWER HINGES - ZINC



Code : 9283
Description: Wall to Glass 90°
Finish : Matt / Glossy



Code : 9284
Description: Glass to Glass 180°
Finish : Matt / Glossy



Code : 9285
Description: Glass to Glass 135°
Finish : Matt / Glossy



Code : 9286
Description: Glass to Glass 90°
Finish : Matt / Glossy



Code : 9287
Description: Fixed Clip
Finish : Matt / Glossy



Code : 9288
Description: Wall to Glass 90°
One Side
Finish : Matt / Glossy

SPIDER FITTING - STAINLESS STEEL 316



Code : 9289
Description: Four Way Spider With Fin
Finish : Matt / Glossy



Code : 9290
Description: Two Way Spider With Fin
Finish : Matt / Glossy



Code : 9291
Description: Two Way Spider
With Fin Installed at 90°
Finish : Matt / Glossy

GLASS FITTINGS



SPIDER FITTING - STAINLESS STEEL 316



Code : 9292

Description : Single Way Spider with Fin Installed at 90°

Finish : Matt / Glossy



Code : 9293

Description : Single Way Spider with Fin Installed at 45° - Right Side

Finish : Matt / Glossy



Code : 9294

Description : Single Way Spider with Fin Installed at 45° - Left Side

Finish : Matt / Glossy



Code : 9295

Description : Four Way Point Type Spider

Finish : Matt / Glossy



Code : 9296

Description : Three Way Point Type Spider

Finish : Matt / Glossy



Code : 9297

Description : Two Way Point Type Spider Installed at 90°

Finish : Matt / Glossy



Code : 9298

Description : Two Way Point Type Spider Installed at 180°

Finish : Matt / Glossy



Code : 9299

Description : Single Way Point Type Spider Installed at 90°

Finish : Matt / Glossy



ROUTE L - STAINLESS STEEL 304



Code : 9300
 Description : Articulated Routel Flat
 Type Head - 60 mm dia Head
 Finish : Matt / Glossy



Code : 9301
 Description : Counter Sunk Routel
 - 45 mm dia Head
 Finish : Matt / Glossy



Code : 9302
 Description : Degree Routel
 - 50 mm dia Head
 Finish : Matt / Glossy



Code : 9303
 Description : Flat Routel -
 50 mm dia Head
 Finish : Matt / Glossy



Code : 9304
 Description : Flt Routel -
 40 mm dia Head
 Finish : Matt / Glossy



Code : 9305
 Description : Stud for Point Type Spider -
 MS Base
 Finish : Matt / Glossy

SPLICE PLATE - STAINLESS STEEL 304



Code : 9306
 Description : Splice Plate 200mm
 Finish : Matt / Glossy



Code : 9307
 Description : Splice Plate 250mm
 Finish : Matt / Glossy



Code : 9308
 Description : Splice Plate 300mm
 Finish : Matt / Glossy

GLASS FITTINGS

SPLICE PLATE - STAINLESS STEEL 304



Code : 9309
Description: Splice Plate 350 mm
Finish : Matt / Glossy



Code : 9310
Description: Splice Plate 400 mm
Finish : Matt / Glossy



FIN PLATE - STAINLESS STEEL 304



Code : 9311
Description: Fin Plate 200 mm
Finish : Matt / Glossy



Code : 9312
Description: Fin Plate 250 mm
Finish : Matt / Glossy



Code : 9313
Description: Fin Plate 300 mm
Finish : Matt / Glossy



Code : 9314
Description: Fin Plate 350 mm
Finish : Matt / Glossy



Code : 9315
Description: Fin Plate 400 mm
Finish : Matt / Glossy



CANOPY FITTING - STAINLESS STEEL 304



Code : 9316
 Description: Wall to Road
 Canopy Fitting
 Finish : Matt / Glossy



Code : 9317
 Description: Road to Glass
 Canopy Fitting
 Finish : Matt / Glossy



Code : 9318
 Description: Wall to Glass
 Canopy Fitting
 Finish : Matt / Glossy

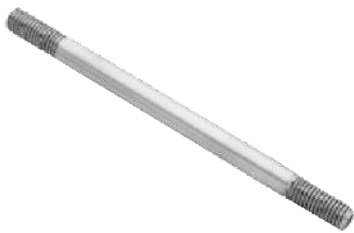

Code : 9319
 Description: Connecting Road Canopy
 Fitting 10 mm Road 1 meter
 Finish : Matt / Glossy

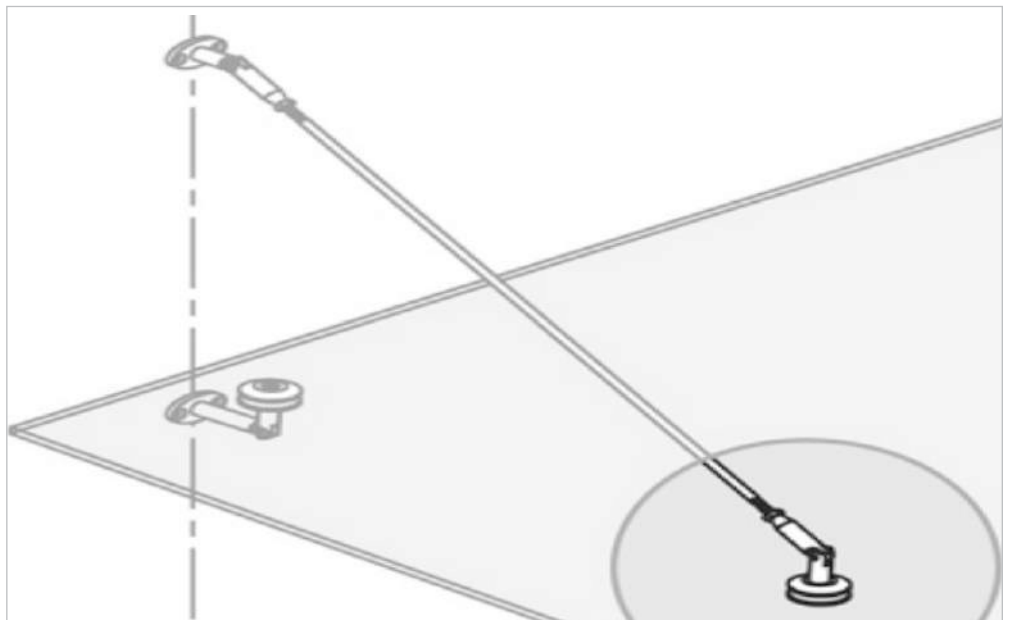

SHOWER GLASS SLIDING SYSTEM - STAINLESS STEEL 304

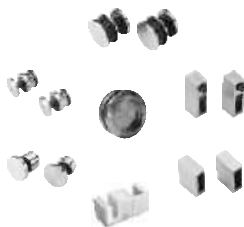

Code : 9320
 Description: Shower Sliding Set
 Finish : Matt / Glossy



Code : 9321
 Description: Rectangle Track 2 meter
 Finish : Matt / Glossy



Code : 9322
 Description: Door Roller for Rectangle
 Sliding Tack
 Finish : Matt / Glossy

GLASS FITTINGS



SHOWER GLASS SLIDING SYSTEM - STAINLESS STEEL 304



Code : 9323
Description : Clamp for Fixing
Rectangle Track to Glass
Finish : Matt / Glossy



Code : 9324
Description : Support for
Rectangular Track
Finish : Matt / Glossy



Code : 9325
Description : Side bracket for
Rectangle Track
Finish : Matt / Glossy



Code : 9326
Description : Door Stoper for
Rectangle Track
Finish : Matt / Glossy



Code : 9327
Description : Floor Guide for One
Fix and One Sliding Door
Finish : Matt / Glossy

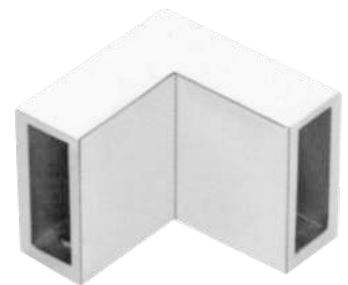

Code : 9328
Description : 90° Side bracket for
Rectangle Track
Finish : Matt / Glossy

GLASS SLIDING FITTING - STAINLESS STEEL 304



Code : 9329
Description : Glass Sliding Fitting for
80 kg. Glass Weight
Finish : Matt / Glossy

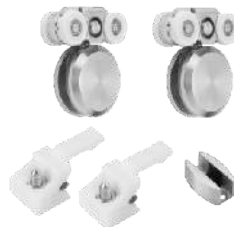

Code : 9330
Description : Glass Sliding Fitting for
100 kg Glass Weight
Finish : Matt



Code : 9331
Description : Top Track for Single Sliding
Size : 12 Feet

GLASS SLIDING FITTING - STAINLESS STEEL 304

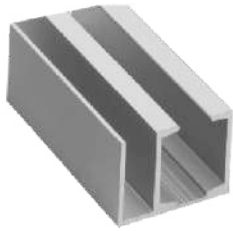

Code : 9332
 Description: Top Track for One Fix and One Sliding
 Size : 12 feet

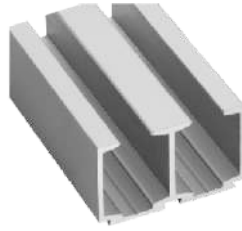

Code : 9333
 Description: Top Track for Double Sliding
 Finish : 12 feet



Code : 9334
 Description: L Clamp for Wall to Track Fixer
 Finish : Matt



Code : 9335
 Description: Floor Mounting Half Door Stopper
 Finish : Matt



Code : 9336
 Description: Floor Guide
 Finish : Matt



SLIDING GLASS DOOR HANDLE - STAINLESS STEEL 304



Code : 9337
 Description: Glass Sliding Handle (Rectangle)
 Finish : Matt



Code : 9338
 Description: Glass Sliding Handle (Rectangle) A
 Finish : Matt



Code : 9339
 Description: Glass Sliding Handle (Square)
 Finish : Matt

GLASS FITTINGS



SLIDING GLASS DOOR HANDLE - STAINLESS STEEL 304



Code : 9340
Description: Glass Sliding Handle
(Regular Size)
Finish : Matt



Code : 9341
Description: Glass Sliding Handle
(Big Size)
Finish : Matt



Code : 9342
Description: Glass Sliding Handle
(Round)
Finish : Matt

GLASS DOOR LOCKS - WITHOUT CUT OUT



Code : 9343
Description: Turn Knob Lock
Finish : Matt



Code : 9344
Description: Turn Knob Lock
with Strike Box
Finish : Matt



Code : 9345
Description: One Side Knob One Side
Key Wall to Glass Lock
Finish : Matt



Code : 9346
Description: One Side Knob One Side
Key Glass to Glass Lock
Finish : Matt



POINT GLASS FITTING SYSTEM - STAINLESS STEEL 304

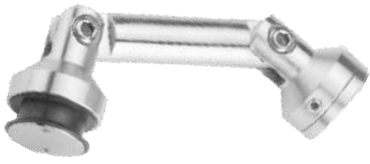

Code : 9347
 Description : Wall to Glass Connector
 Both Side Adjustable
 Size : 60mm, 82mm, 103mm



Code : 9348
 Description : Wall to Glass
 Connector Fix
 Size : 75mm, 103mm



Code : 9349
 Description : Glass to Glass Connector
 Both Side Adjustable
 Size : 60mm, 82mm, 103mm

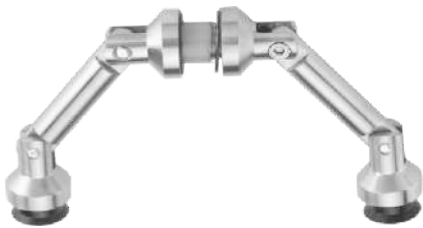

Code : 9350
 Description : Glass to Glass Connector
 Adjustable with Fin
 Size : 60mm, 82mm, 103mm



MORTISE HANDLE - STAINLESS STEEL 304



Code : 9351
 Description : Mortise Handle
 (22mm)
 Finish : Matt



Code : 9352
 Description : Mortise Handle
 (22mm)
 Finish : Matt

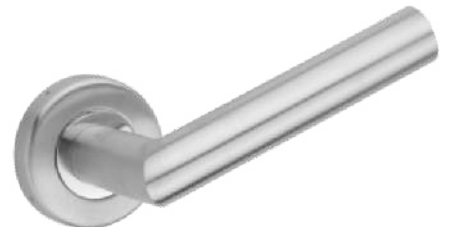

Code : 9353
 Description : Mortise Handle
 (22mm)
 Finish : Matt

MORTISE HANDLE

STAINLESS STEEL 304



Code : 9354
Description: Mortise Handle
(22mm)
Finish : Matt



Code : 9355
Description: Mortise Handle
(22mm)
Finish : Matt



Code : 9356
Description: Mortise Handle
(20mm)
Finish : Matt

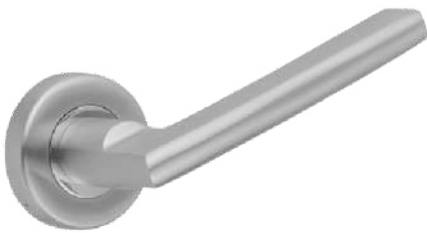

Code : 9357
Description: Mortise Handle
(Solid)
Finish : Matt



Code : 9358
Description: Mortise Handle
(Solid)
Finish : Matt

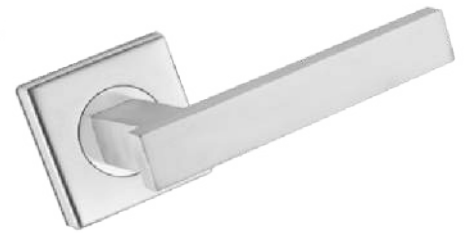

Code : 9359
Description: Mortise Handle
(Solid)
Finish : Matt

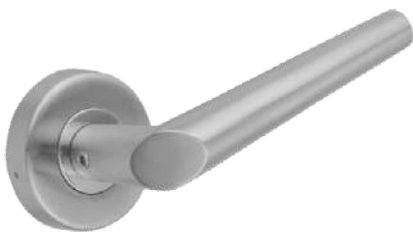

Code : 9360
Description: Mortise Handle
(Solid)
Finish : Matt



Code : 9361
Description: Mortise Handle
(Solid)
Finish : Matt



Code : 9362
Description: Mortise Handle
(Solid)
Finish : Matt

GLASS DOOR HANDLE - STAINLESS STEEL 304

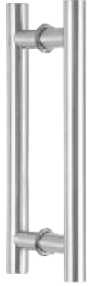

Code : 9363
 Description: H Type Glass Door Handle - Matt
 Size : 22 x 200/250/300/350
 25 x 300/350/400/450/500/550/600/900
 32 x 600/900



Code : 9364
 Description: D Type Glass Door Handle - Matt
 Size : 22 x 200/250/300/350
 25 x 300/350/400/450/500/550/600/900



Code : 9365
 Description: S Type Glass Door Handle - Matt
 Size : 22 x 200/250/300



Code : 9366
 Description: Glass Door Handle - Matt
 Size : 22 x 200/250/300/350
 25 x 300/350/400/450/600
 32 x 450/600/900



Code : 9367
 Description: Square D Type Glass Door Handle - Matt
 Size : 20 x 200/250/300/350/400/450
 25 x 300/350/400/450/600/900



Code : 9368
 Description: Double Pipe Glass Door Handle - Combi
 Size : 22 x 300/350/450
 25 x 300/450/600



Code : 9369
 Description: C Type Glass Door Handle - Matt
 Size : 22 x 200/250/300
 25 x 200/250/300



Code : 9370
 Description: Single Band Glass Door Handle - Matt
 Size : 22 x 200/250/300
 25 x 300/450/600

STAINLESS STEEL 304



Code : 9371

Description: Baluster with Two Glass Holder - 800mm Height

Finish : Matt



Code : 9372

Description: Baluster with Two Glass Holder - 800mm Height

Finish : Matt



Code : 9373

Description: Baluster with 3 Pipe Holder - 800mm Height

Finish : Matt



Code : 9374

Description: Pipe Baluster with Two Glass Holder - 800mm Height

Finish : Matt



Code : 9375

Description: Baluster with Two Glass Holder - 300mm Height

Finish : Matt



Code : 9376

Description: Baluster with Two Glass Holder - 300mm Height

Finish : Matt



Code : 9377

Description: Floor Mounting Spigot - 125mm Height

Finish : Matt



Code : 9378

Description: Floor Mounting Spigot - 125mm Height

Finish : Matt



STAINLESS STEEL 304



Code : 9379
 Description : Top Mounted Pipe to Glass Railing Accessories
 Finish : Matt



Code : 9380
 Description : Top Mounted Pipe to Glass Railing Accessories
 Finish : Matt



Code : 9381
 Description : Wall to Pipe Railing Accessories
 Finish : Matt



Code : 9382
 Description : Side Mounted Glass Railing Accessories
 Finish : Matt



Code : 9383
 Description : Stud for Side Mounting Glass Railing
 Finish : Matt



Code : 9384
 Description : Adjustable Elbow
 Size : 38mm / 50mm



Code : 9385
 Description : Non Adjustable Elbow
 Size : 38mm / 50mm



Code : 9386
 Description : End Cap
 Size : 16mm/38mm/50mm



Code : 9387
 Description : Concealed Cap
 Size : 38mm / 50mm

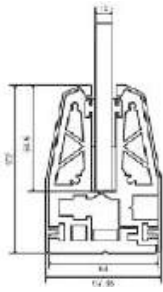

Code : 9388

Description : Bottom Bracket for 10mm & 12mm Glass with Gasket & Anchor Fastner

Size : 70mm/140mm



Code : 9389

Description : Bottom Bracket for 10mm & 12mm Glass with Gasket & Anchor Fastner

Size : 70mm/140mm

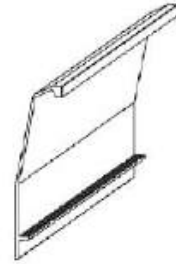

Code : 9390

Description : Cover Profile for Bottom Bracket - (Both Side in Pair)

Finish : Silver/Champaign



Code : 9391

Description : Cover Profile for Bottom Bracket (Both Side in Pair)

Size : Silver / Champaign



Code : 9392

Description : Top Hand Rail

Finish : Silver / Champaign

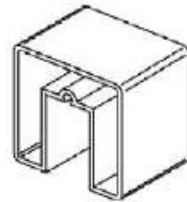

Code : 9393

Description : Top Hand Rail

Finish : Silver/Champaign

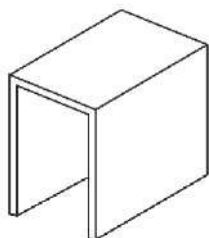

Code : 9394

Description : Top Hand Rail

Finish : Silver/Champaign

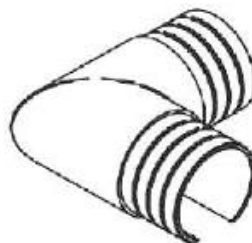

Code : 9395

Description : 90° Elbow for Round Pipe

Finish : Chrome

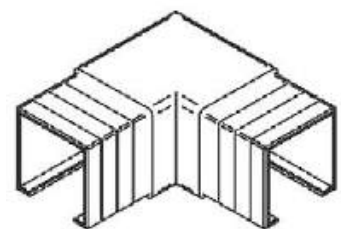

Code : 9396

Description : Concealed Cap

Finish : Chrome

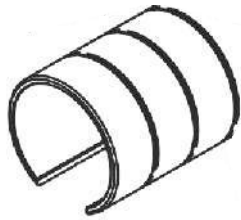

Code : 9397
 Description : Pipe Jointer for Top Round Pipe
 Finish : Chrome

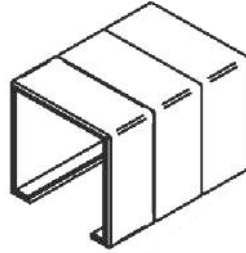

Code : 9398
 Description : Pipe Jointer for Top Square Pipe
 Finish : Chrome

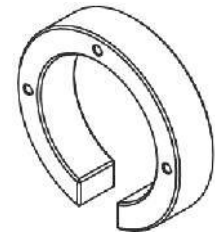

Code : 9399
 Description : Wall Concealed Cap for Round Pipe
 Finish : Chrome

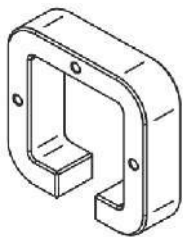

Code : 9400
 Description : Wall Concealed Cap for Square Pipe
 Finish : Chrome



Code : 9401
 Description : End Cap for AR-ARB-01
 Finish : Chrome



Code : 9402
 Description : End Cap for AR-ARB-02
 Finish : Chrome

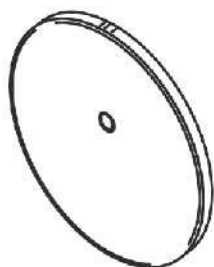

Code : 9403
 Description : End Cap for Top Round Pipe
 Finish : Chrome

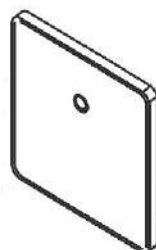

Code : 9404
 Description : End Cap for Top Square Pipe
 Finish : Chrome





INDEX

TOPICS

PAGE

Main Door Handles	101 - 103
Mortise Door Handles	104 - 107
Locking System :	108 - 112
Cylinder Locks / Lock Body / Combo Set / Main Door Locks / Drawer Locks / Sliding Door Lock	

MAIN DOOR HANDLES



Code : 9405
Finish : Antique,
Copper Antique,
Black, Rose Gold
Size : 300mm, 450mm
Material : Brass



Code : 9406
Finish : Antique,
Copper Antique,
Black, Rose Gold
Size : 300mm, 450mm
Material : Brass



Code : 9407
Finish : Antique,
Copper Antique,
Black, Rose Gold
Size : 300mm, 450mm
Material : Brass



Code : 9408
Finish : Antique,
Copper Antique,
S.S.
Size : 300mm (H to H)
Material : Brass



Code : 9409
Finish : Antique,
Copper Antique,
S.S.
Size : 300mm (H to H)
Material : Brass



Code : 9410
Finish : Antique,
Copper Antique,
Black/Gold
Size : 300mm (H to H)
Material : Brass



Code : 9411
 Finish : Antique
 Size : 300mm (H to H)
 Material : Brass



Code : 9412
 Finish : Antique
 Size : 300mm (H to H)
 Material : Brass



Code : 9413
 Finish : Antique, Rose Gold/Black
 Size : 300mm, 450mm, 600mm (H to H)
 Material : Brass



Code : 9414
 Finish : Antique, Black Matt, S.S.
 Size : 300mm (H to H)
 Material : Brass



Code : 9415
 Finish : Antique, Rose Gold/Black
 Size : 300mm, 450mm (H to H)
 Material : Brass



Code : 9416
 Finish : Antique, Black Matt S.S.
 Size : 300mm (H to H)
 Material : Brass

MAIN DOOR HANDLES



Code : 9417
 Finish : Antique
 Size : 300mm (H to H)
 Material : Brass



Code : 9418
 Finish : Antique
 Size : 300mm (H to H)
 Material : Brass

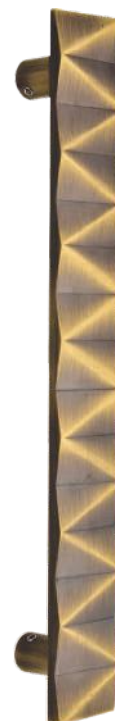

Code : 9419
 Finish : Antique
 Size : 300mm, 375mm & 450mm (H to H)
 Material : Brass



Code : 9420
 Finish : Antique, Chrome
 Size : 300mm (H to H)
 Material : Brass



Code : 9421
 Finish : Antique, Chrome
 Black Matt, S.S.
 Size : 300mm (H to H)
 Material : Brass



Code : 9422
 Finish : Antique,
 Copper Antique,
 Black Matt, S.S.
 Size : 300mm (H to H)
 Material : Brass



Code : 9423
 Description : Mango
 Finish : SS / AB / RG / FB
 Material : Brass



Code : 9424
 Description : Corsa
 Finish : SS / AB / RG / FB
 Material : Brass



Code : 9425
 Description : Lyon
 Finish : SS / AB / RG / FB
 Material : Brass



Code : 9426
 Description : Si
 Finish : SS / AB / RG / FB
 Material : Brass



Code : 9427
 Description : Cabo
 Finish : SS / AB / RG / FB
 Material : Brass



Code : 9428
 Description : Lugo
 Finish : SS / AB / RG / FB
 Material : Brass



Code : 9429
 Description : Cornish
 Finish : SS / AB / RG / FB
 Material : Brass



Code : 9430
 Description : Deer
 Finish : SS / AB / RG / FB
 Material : Brass



Code : 9431
 Description : Loyce
 Finish : SS / AB / RG / FB
 Material : Brass



Code : 9432
 Description : Frilly
 Finish : SS / AB / RG / FB
 Material : Brass

MORTISE HANDLES



Code : 9433
 Finish : Chrome, SS Matt, Satin,
 Antique Brass, Rose Gold,
 Antique Copper, Matt Black
 Material : White Metal



Code : 9434
 Finish : Chrome, SS Matt, Satin,
 Antique Brass, Rose Gold,
 Antique Copper, Matt Black
 Material : White Metal



Code : 9435
 Finish : Chrome, SS Matt, Satin,
 Antique Brass, Rose Gold,
 Antique Copper, Matt Black
 Material : White Metal



Code : 9436
 Finish : Chrome, SS Matt, Satin,
 Antique Brass, Rose Gold,
 Antique Copper, Matt Black
 Material : White Metal



Code : 9437
 Finish : Chrome, SS Matt, Satin,
 Antique Brass, Rose Gold,
 Antique Copper, Matt Black
 Material : White Metal



Code : 9438
 Finish : Chrome, SS Matt, Satin,
 Antique Brass, Rose Gold,
 Antique Copper, Matt Black
 Material : White Metal



Code : 9439
 Finish : Chrome, SS Matt, Satin,
 Antique Brass, Rose Gold,
 Antique Copper, Matt Black
 Material : White Metal



Code : 9440
 Finish : Chrome, SS Matt, Satin,
 Antique Brass, Rose Gold,
 Matt Rose Gold,
 Antique Copper, Matt Black
 Material : White Metal



Code : 9441
 Finish : Chrome, SS Matt, Satin,
 Antique Brass, Rose Gold,
 Antique Copper, Matt Black
 Material : White Metal



Code : 9442
 Finish : Chrome, SS Matt, Satin,
 Antique Brass, Rose Gold,
 Antique Copper, Matt Black
 Material : White Metal



Code : 9443
 Finish : Chrome, SS Matt, Satin,
 Antique Brass, Rose Gold,
 Antique Copper, Matt Black
 Material : White Metal



Code : 9444
 Finish : Chrome, SS Matt, Satin,
 Antique Brass, Rose Gold,
 Antique Copper, Matt Black
 Material : White Metal



Code : 9445
 Finish : Chrome/White Acrylic,
 Satin/Wengi Acrylic,
 Black Satin/White Acrylic,
 Antique Brass/Black Acrylic
 Material : White Metal



Code : 9446
 Finish : Chrome, SS Matt, Satin,
 Antique Brass, Rose Gold,
 Antique Copper, Matt Black
 Material : White Metal

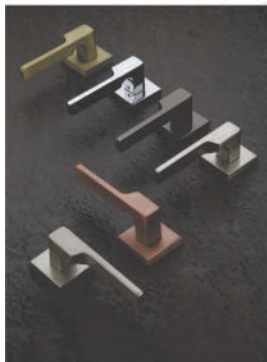

Code : 9447
 Finish : Chrome, SS Matt, Satin,
 Antique Brass, Rose Gold,
 Antique Copper, Matt Black
 Material : White Metal



Code : 9448
 Finish : Chrome, SS Matt, Satin,
 Antique Brass, Rose Gold,
 Antique Copper, Matt Black
 Material : White Metal



Code : 9449
 Finish : Chrome, SS Matt, Satin,
 Antique Brass, Rose Gold,
 Antique Copper, Matt Black
 Material : White Metal

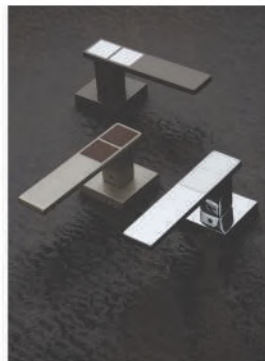

Code : 9450
 Finish : Chrome/White Acrylic,
 Satin/Wengi Acrylic,
 Black Satin/White Acrylic,
 Antique Brass/Black Acrylic
 Material : White Metal



Code : 9451
 Finish : Chrome, SS Matt, Satin,
 Antique Brass, Rose Gold,
 Antique Copper, Matt Black
 Material : White Metal



Code : 9452
 Finish : Chrome, SS Matt, Satin,
 Antique Brass, Rose Gold,
 Antique Copper, Matt Black
 Material : White Metal



Code : 9453

Finish : Chrome/Satin, Satin Chrome,
Antique Brass, Rose Gold/
(Glossy/Matt), Matt Black/
Rose Gold, Matt Black/Gold

Material : White Metal



Code : 9454

Finish : Chrome, SS Matt, Satin,
Antique Brass, Rose Gold,
Antique Copper, Matt Black

Material : White Metal



Code : 9455

Finish : Chrome/Satin, SS Matt/Chrome,
SS Matt/Matt Black,
Antique Brass/Black,
Rose Gold (Glossy-Matt),
Matt Black/Rose Gold,
Matt Black/Gold

Material : White Metal



Code : 9456

Finish : Chrome, SS Matt, Satin,
Antique Brass, Rose Gold,
Antique Copper, Matt Black

Material : White Metal



Code : 9457

Finish : Chrome/Satin,
SS Matt/Wengi,
Antique Brass/Black,
Rose Gold/Matt Black,
Gold/Matt Black

Material : White Metal



Code : 9458

Finish : Chrome, SS Matt, Satin,
Antique Brass, Rose Gold,
Antique Copper, Matt Black

Material : White Metal

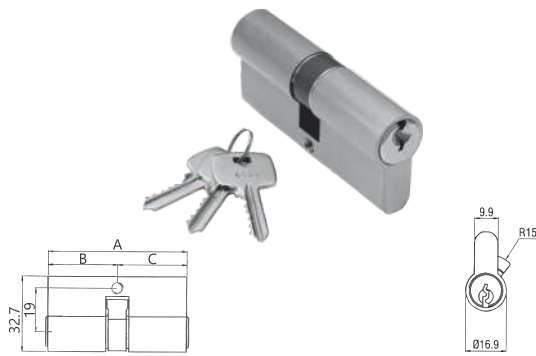

Code : 9459
 Description : Euro Profile Double Cylinder
 Finish : Chrome/Satin, Satin Chrome, Antique Brass, Rose Gold/ (Glossy/Matt), Matt Black/ Rose Gold, Matt Black/Gold

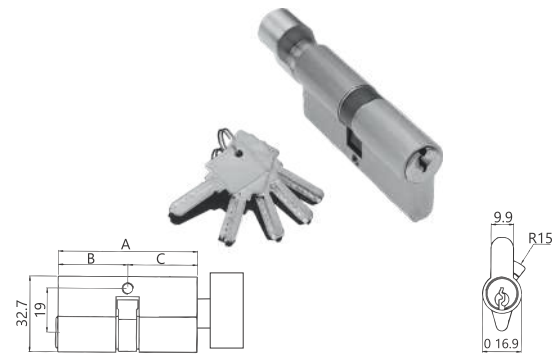

Code : 9460
 Description : Euro Profile Thumb Turn Cylinder
 Finish : Chrome/Satin, Satin Chrome, Antique Brass, Rose Gold/ (Glossy/Matt), Matt Black/ Rose Gold, Matt Black/Gold

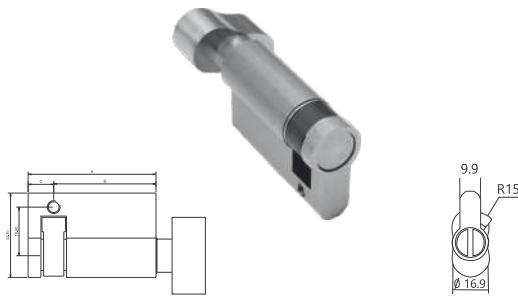

Code : 9461
 Description : Euro Profile Thumb Turn Half Cylinder Range
 Finish : Chrome/Satin, Satin Chrome, Antique Brass, Rose Gold/ (Glossy/Matt), Matt Black/ Rose Gold, Matt Black/Gold



Code : 9462
 Description : Euro Profile Half Cylinder Range
 Finish : Chrome/Satin, Satin Chrome, Antique Brass, Rose Gold/ (Glossy/Matt), Matt Black/ Rose Gold, Matt Black/Gold

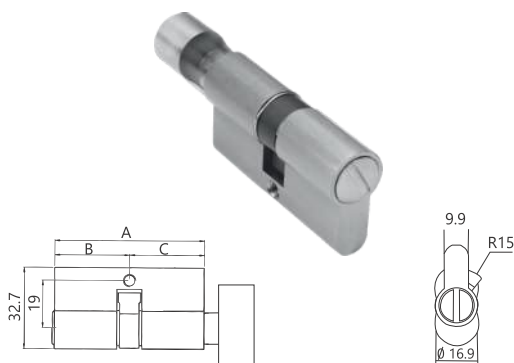

Code : 9463
 Description : Euro Profile Privacy Cylinder Range
 Finish : Chrome/Satin, Satin Chrome, Antique Brass, Rose Gold/ (Glossy/Matt), Matt Black/ Rose Gold, Matt Black/Gold

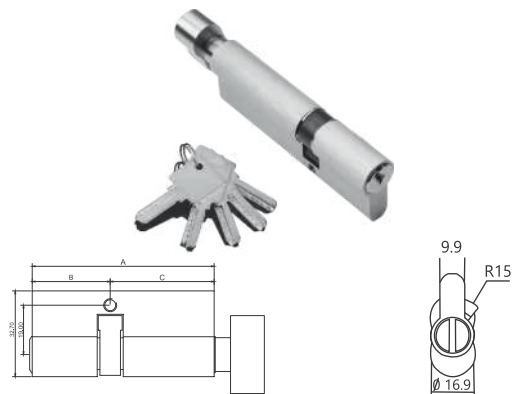

Code : 9464
 Description : Euro Profile Offset Cylinder Range
 Finish : Chrome/Satin, Satin Chrome, Antique Brass, Rose Gold/ (Glossy/Matt), Matt Black/ Rose Gold, Matt Black/Gold

LOCK BODY



Code : 9465
Size : 9" (45mm x 85mm)
Finish : SS, AB, CP



Code : 9466
Size : 9" (45mm x 85mm)
Finish : SS, AB, CP



Code : 9467
Size : 9" (50mm x 85mm)
Finish : SS, AB, CP



Code : 9468
Size : 7" (Dead Lock)
Finish : SS, AB, CP



Code : 9469
Size : Baby Latch
Finish : SS, AB, CP

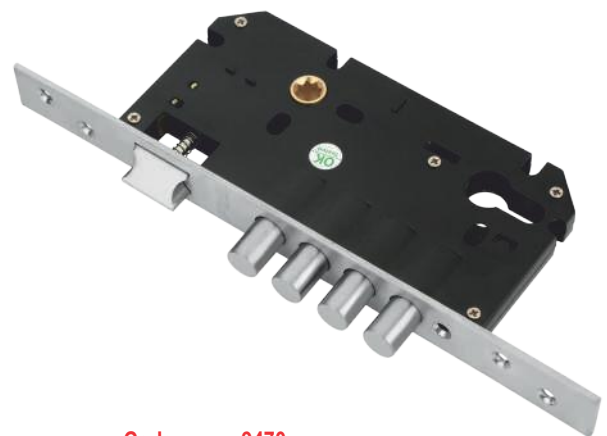

Code : 9470
Size : 9" (60mm x 85mm)
Finish : SS, AB, CP

COMBO SET

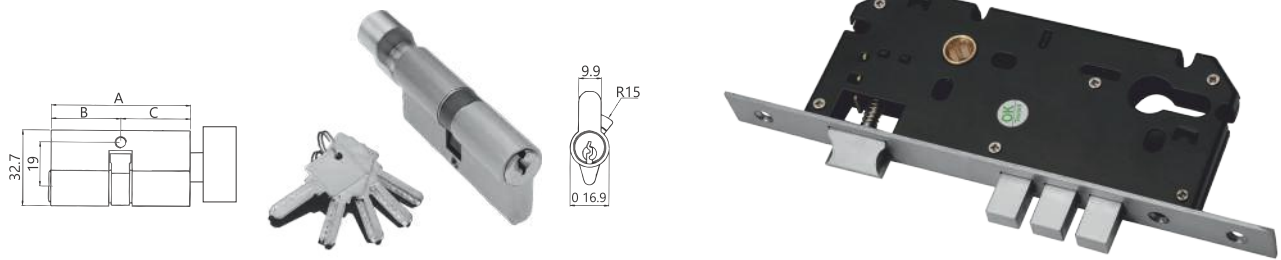

Code : 9471

Size : 9" (45mm x 85mm)

Finish : SS, AB, CP

Material : Cylinder White Metal (Inner Parts Brass and Key Brass)
Body Material MS, Steel and Brass

MAIN DOOR & SAFETY DOOR LOCKS



Code : 9472

Material : Mild Steel

Finish : Silver / Antique



Code : 9473

Material : Mild Steel

Finish : Silver / Antique



Code : 9474

Material : Mild Steel

Finish : Silver / Antique

DRAWER LOCK



Code : 9475

Material : Brass, Zinc, PC
 Finish : Sand Blast Chrome
 Packing : Sand Blast Chrome

(Cylindrical Lock with Ultra Key)



Code : 9476

Material : Stainless Steel & Brass Key
 Finish : Brush Steel
 With Box Packing Weight 550 gms
 Brass 3pcs.Key Weight 42gms
 Ball Weight 450 gms

(Cylindrical Lock for Bathroom)



Code : 9477

Material : Stainless Steel
 Finish : Brush Steel
 With Box Packing Weight 550 gms
 Ball Weight 450 gms

(Sliding Door Lock)



Code : 9478

Material : Mild Steel, Stainless Steel & Brass Key
 Finish : Brush Steel

(Sliding Door Lock)



Code : 9479

Material : Mild Steel, Stainless Steel & Brass Key
 Finish : Brush Steel

STAR KEY SLIDING LOCK

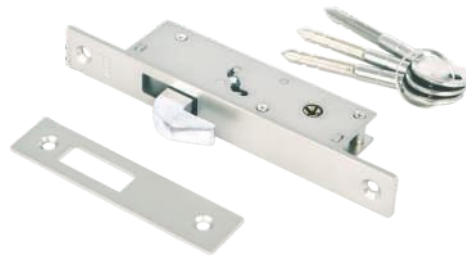

Code : 9480

Material : Stainless Steel, Mild Steel, Brass

Finish : Brush Steel

STAR KEY PARDER LOCK



Code : 9481

Material : Stainless Steel, Mild Steel, Brass

Finish : Brush Steel

STAR KEY SLIDING LOCK



Code : 9482

Material : Stainless Steel, Mild Steel, Brass

Finish : Brush Steel

STAR KEY DEAD LOCK



Code : 9483

Material : Stainless Steel, Mild Steel, Brass

Finish : Brush Steel



INDEX

TOPICS

PAGE

Slotted channels & Brackets	113 - 134
Partition & Pipe Fittings	135
Alluminium Sliding Channels & Glazing Profiles	136

Double Slot Channel & Bracket-Standard-Ivory Powder Coated

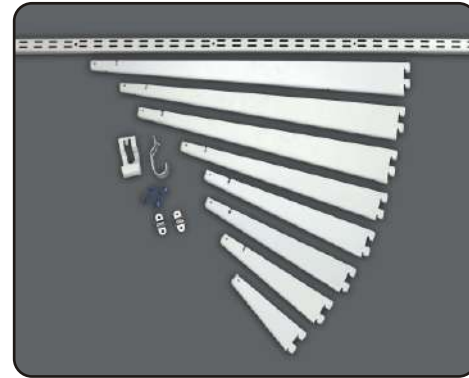
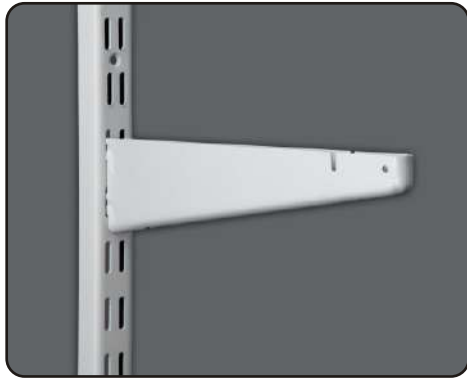

Product Code : DSCB-STD-PC-H

CODE	DESCRIPTION	SIZE	THICKNESS	QTY./BOX(NOS.)
9484	DSB—STD—PC—6. 1.2	6"	1.2mm/18swg	100
9485	DSB-STD-PC-9.1.2	9"	1.2mm/18swg	100
9486	DSB—STD—PC—13.1.2	13"	1.2mm/18swg	100
9487	DSB-STD-PC-15.1.2	15"	1.2mm/18swg	100
9488	DSB-STD—PC—17.1.2	17"	1.2mm/18swg	100
9489	DSB-STD-PC—20. 1.2	20"	1.2mm/18swg	100
9490	DSB—STD—PC—22. 1.2	22"	1.2mm/18swg	100
9491	DSB-STD-PC-25.1.2	25"	1.2mm/18swg	100
9492	DSC—STD—PC-4. 1.8	4'	1.8mm/14swg	30
9493	DSC-STD-PC-6. 1.8	6'	1.8mm/14swg	30
9494	DSC-STD-PC-8. 1.8	8'	1.8mm/14swg	30
9495	PH B-PC	Pipe Holding Bracket		100
9496	SSC	S.S.. Clip		50
9497	VE	Vaccume		144

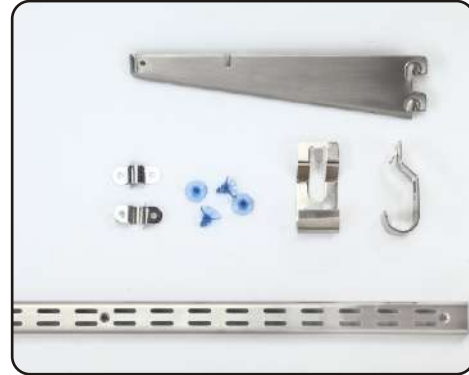
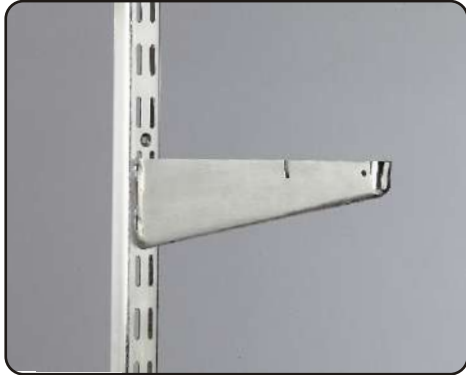

Product Code : DSCB - STD - SSGL

CODE	DESCRIPTION	SIZE	THICKNESS	QTY./BOX(NOS.)
9498	DSB-STD-SSGL-6	6"	1.00mm/20swg	100
9499	DSB-STD-SSGL-9	9"	1.00mm/20swg	100
9500	DSB-STD-SSGL-13	13"	1.00mm/20swg	100
9501	DSB-STD-SSGL-15	15"	1.00mm/20swg	100
9502	DSB-STD-SSGL-17	17"	1.00mm/20swg	100
9503	DSB-STD-SSGL-20	20"	1.2mm/18swg	100
9504	DSB-STD-SSGL-22	22"	1.2mm/18swg	100
9505	DSB-STD-SSGL-25	25"	1.2mm/18swg	100
9506	DSC-STD-SSMT-4	4'	1.5mm/16swg	30
9507	DSC-STD-SSGL-6	6'	1.5mm/16swg	30
9508	DSC-STD-SSG L-8	8'	1.5mm/16swg	30
9509	PH B-SSGL	Pipe Holding Bracket		100
9510	SSC	S.S. Clip		50
9511	VE	Vaccume		144

Double Slot Channel & Bracket-Standard-S.S. Matt Finish

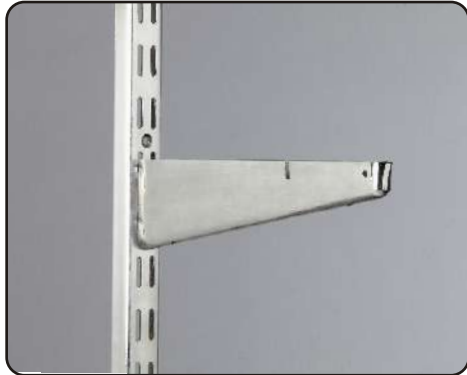

Product Code : DSCB - STD - SSMT

CODE	DESCRIPTION	SIZE	THICKNESS	QTY./BOX(NOS.)
9512	DSB-STD-SSMT-6	6"	1.00mm/20swg	100
9513	DSB-STD-SSMT-9	9"	1.00mm/20swg	100
9514	DSB-STD-SSMT-13	13"	1.00mm/20swg	100
9515	DSB-STD-SSMT-15	15"	1.00mm/20swg	100
9516	DSB-STD-SSMT-17	17"	1.00mm/20swg	100
9517	DSB-STD-SSMT-20	20"	1.2mm/18swg	100
9518	DSB-STD-SSMT-22	22"	1.2mm/18swg	100
9519	DSB-STD-SSMT-25	25"	1.2mm/18swg	100
9520	DSC-STD-SSMT-4	4'	1.5mm/16swg	30
9521	DSC-STD-SSMT-6	6'	1.5mm/16swg	30
9522	DSC-STD-SSMT-8	8'	1.5mm/16swg	30
9523	PH B-SSMT	Pipe Holding Bracket		100
9524	SSC	S.S. Clip		50
9525	VE	Vaccume		144

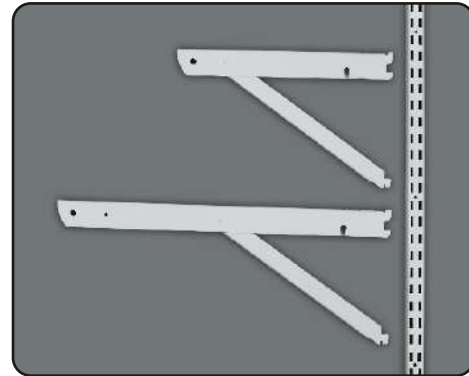

Product Code : DSCB - HD - PC

CODE	DESCRIPTION	SIZE		QTY./BOX(NOS.)
9526	DSB-HD-PC-9	9"		100
9527	DSB-HD-PC-12	12"		100
9528	DSB-HD-PC-15	15"		100
9529	DSB-HD-PC-18	18"		100
9530	DSC-HD-PC-4	4'		30
9531	DSC-HD-PC-6	6'		30
9532	DSC-HD-PC-8	8'		30
9533	VE	Vaccume	2.00	144

Single Slot Channel & Bracket-S.S. Matt Finish



Product Code : SSCB - STD - SSMT

CODE	DESCRIPTION	SIZE		QTY./BOX(NOS.)
9534	SSB-STD-SSMT-6	6"		100
9535	SSB-STD-SSMT-8	8"		100
9536	SSB-STD-SSMT-10	10"		100
9537	SSB-STD-SSMT-12	12"		100
9538	SS B-STD-SS MT- 14	14"		100
9539	SSB-STD-SSMT-16	16"		100
9540	SSB-STD-SSMT-18	18"		100
9541	SSC-STD-SSMT-4.1.2	4'		50
9542	SSC-STD-SSMT-6. 1.2	6'		50
9543	SSC-STD-SSMT-7.1.2	7'		50
9544	SSC-STD-SSMT-8.1.2	8'		50
9545	VE	Vaccume	2.00	144

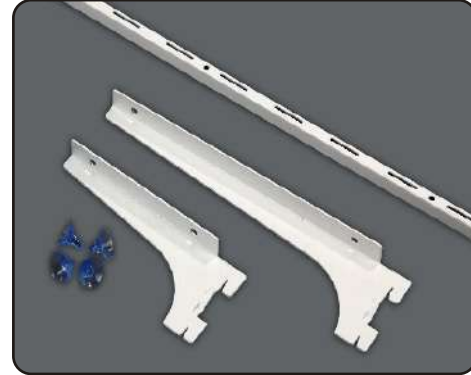

Product Code : SSCB - STD - PC

CODE	DESCRIPTION	SIZE	QTY./BOX(NOS.)
9546	SSB-STD-PC-6	6"	100
9547	SSB-STD-PC-8	8"	100
9548	SSB-STD-PC-10	10"	100
9549	SSB-STD-PC-12	12"	100
9550	SSB-STD-PC-14	14"	100
9551	SSB-STD-PC-16	16"	100
9552	SSB-STD-PC-18	18"	100
9553	SSC-STD-PC-4.1.2	4'	50
9554	SSC-STD-PC-6.1.2	6'	50
9555	SSC-STD-PC-7.1.2	7'	50
9556	SSC-STD-PC-8.1.2	8'	50
9557	VE	Vaccume	2.00
			144

Tripple Slot Channel & Bracket-Powder Coated

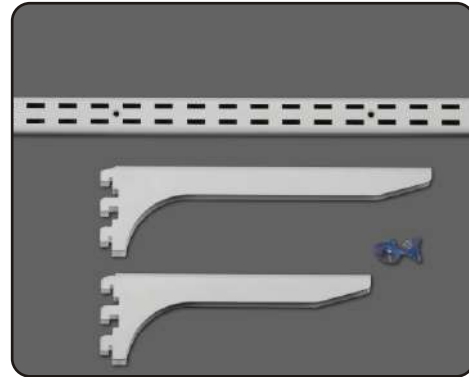
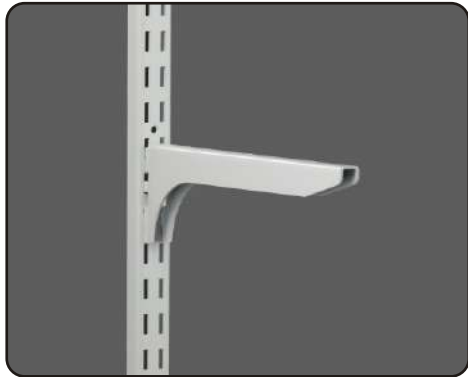

Product Code : TSCB - STD - PC - H

CODE	DESCRIPTION	SIZE	THICKNESS	QTY./BOX(NOS.)
9558	TSB-STD-PC-6. 1.8	6"	1.8mm/14swg	120
9559	TSB-STD-PC-8. 1.8	8"	1.8mm/14swg	120
9560	TSB-STD-PC-10.1.8	10"	1.8mm/14swg	120
9561	TSB-STD-PC-1 2.1.8	12"	1.8mm/14swg	120
9562	TSB-STD-PC-1 5.1.8	15"	1.8mm/14swg	120
9563	TSB-STD-PC-17.1.8	17"	1.8mm/14swg	120
9564	TSC-STD-PC-4.1.8	4'	1.8mm/14swg	30
9565	TSC-STD-PC-6.1.8	6'	1.8mm/14swg	30
9566	TSC-STD-PC-8. 1.8	8'	1.8mm/14swg	30
9567	VACCUME	-	PVC	144.00



Product Code : SSCB - STD - SS - R1

CODE	DESCRIPTION	SIZE	THICKNESS	QTY./BOX(NOS.)
9568	SSCB-STD-SS-14 IB	10 mm	1.0mm/20swg	500
9569	SSCC-STD-SS-8.15.8	4'	1.0mm/20swg	30
9570	SSCC-STD-SS-8.15.8	6'	1.0mm/20swg	30
9571	VACCUME	PVC		500

Clip Bracket & Channel SS Matt Finish - R2



Product Code : SSCB - STD - SS - R2

CODE	DESCRIPTION	SIZE	THICKNESS	QTY./BOX(NOS.)
9572	SSCB-STD-SS- 14	14 mm	1.0mm/20swg	500
9573	SSCC-STD-SS-8. 1 5.8	4'	1.0mm/20swg	30
9574	SSCC-STD-SS-8. 1 5.8	6'	1.0mm/20swg	30
9575	VACCUME	PVC		500



Product Code : SSCB - STD - SS - R3

CODE	DESCRIPTION	SIZE	THICKNESS	QTY./BOX(NOS.)
9576	SSCB-STD-SS-10	10 mm	1.0mm/20swg	500
9577	SSCC—STD—SS-8.15.8	4'	1.0mm/20swg	30
9578	SSCC-STD-SS-8.15.8	6'	1.0mm/20swg	30
9579	VACCUME	PVC		500

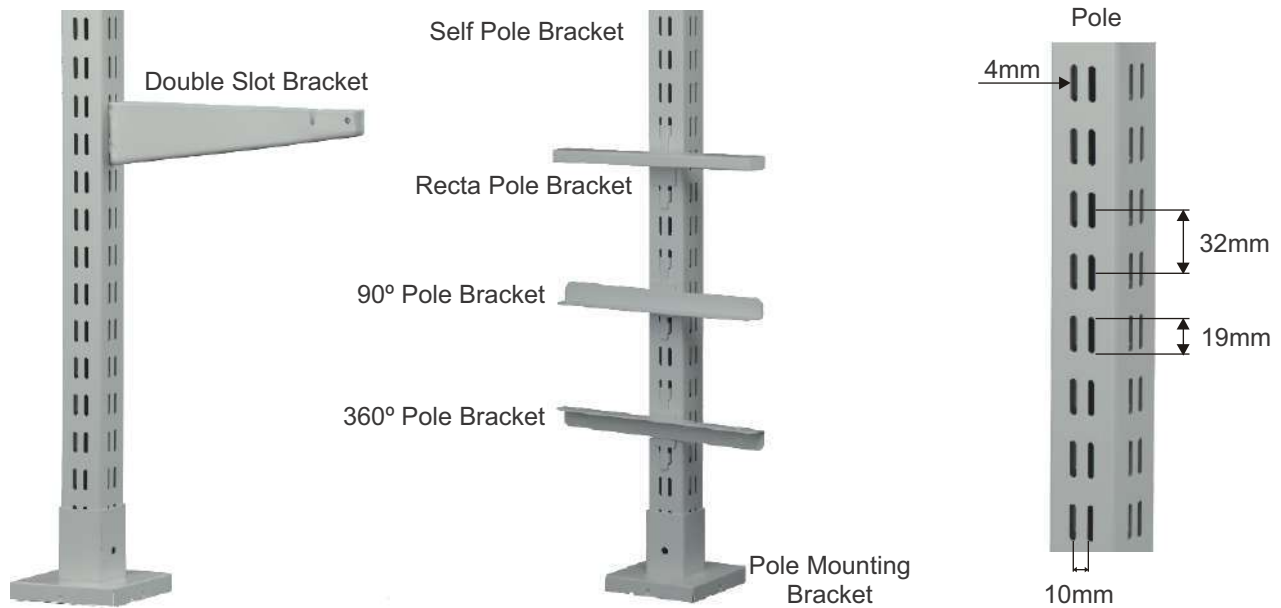

Application & Utilization Technique

Product Code : 40 x 40 - DSDL - 19 x 4 - PC

Pole



CODE	DESCRIPTION	SIZE	THICKNESS
9580	40.40.DSDL.19.4.P.C.1.2.4	4'	1.2mm/18swg
9581	40.40.DSDL.19.4.P.C.1.2.6	6'	1.2mm/18swg
9582	40.40.DSDL.19.4.P.C.1.2.8	8'	1.2mm/18swg
9583	40.40.DSDL.19.4.P.C.1.2.10	10'	1.2mm/18swg
9584	40.40.DSDL.19.4.P.C.1.5.4	4'	1.2mm/16swg
9585	40.40.DSDL.19.4.P.C.1.5.6	6'	1.2mm/16swg
9586	40.40.DSDL.19.4.P.C.1.5.8	8'	1.2mm/16swg
9587	40.40.DSDL.19.4.P.C.1.5.10	10'	1.2mm/16swg



Recta Pole Bracket

CODE	DESCRIPTION	THICKNESS
9588	PMB.PC	2.00MM

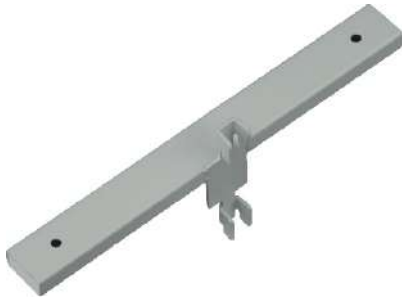

90° Pole Bracket

CODE	DESCRIPTION	SIZE	THICKNESS
9589	RPB.DSDL.19.4.P.C.1.2.6	6"	1.20mm
9590	RPB.DSDL.19.4.P.C.1.2.9	9"	1.20mm
9591	RPB.DSDL.19.4.P.C.1.2. 12	12"	1.20mm
9592	RPB.DSDL.19.4.P.C.1.2. 15	15"	1.20mm
9593	RPB.DSDL.19.4.P.C.1.2. 18	18"	1.20mm

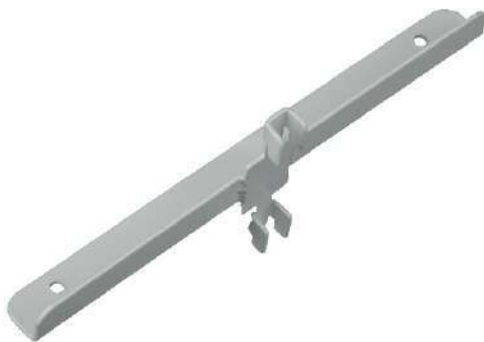

360° Pole Bracket

CODE	DESCRIPTION	SIZE	THICKNESS
9594	90PB.DSDL.19.4.P.C.2.6	6"	2.00mm
9595	90PB.DSDL.19.4.P.C.2.9	9"	2.00mm
9596	90PB.DSDL. 19.4.P.C.2. 12	12"	2.00mm
9597	90PB.DSDL. 19.4. P.C.2. 15	15"	2.00mm
9598	90PB.DSDL. 19.4.P.C.2. 18	18"	2.00mm

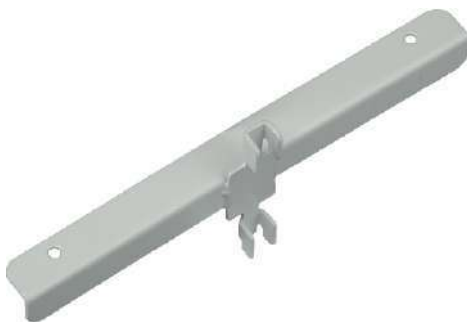

CODE	DESCRIPTION	SIZE	THICKNESS
9599	360PB.DSDL.19.4.P.C.2.6	6"	2.00mm
9600	360PB.DSDL.19.4.P.C.2.9	9"	2.00mm
9601	360PB.DSDL.19.4.P.C.2.12	12"	2.00mm
9602	360PB.DSDL.19.4.P.C.2.15	15"	2.00mm
9603	360PB.DSDL.19.4.P.C.2.18	18"	2.00mm

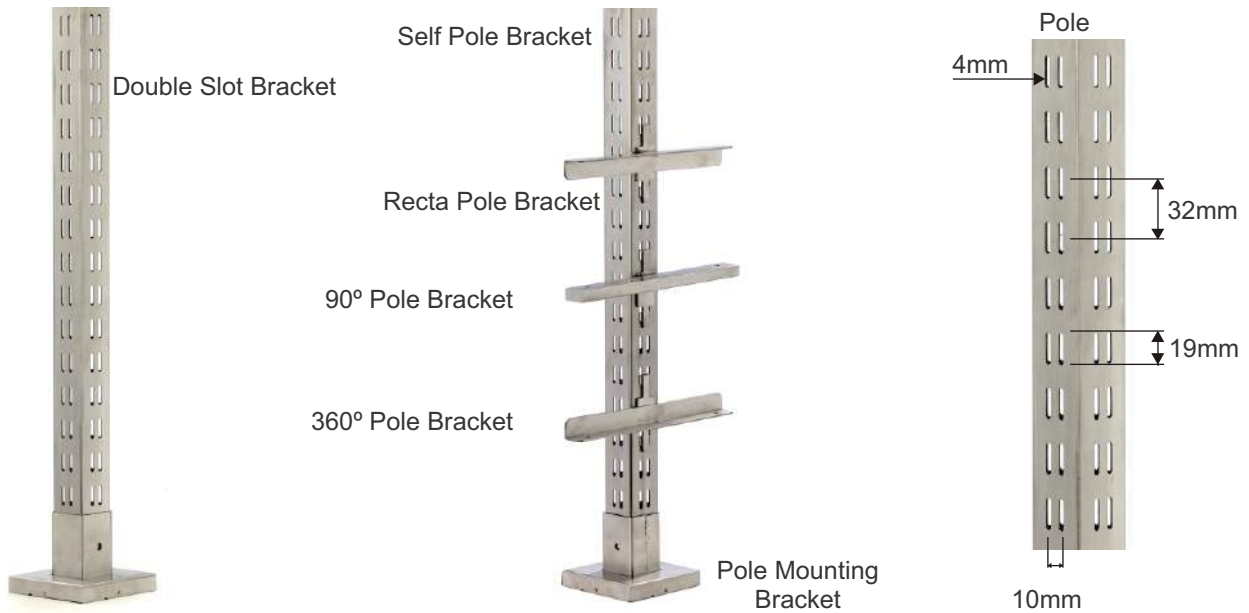

Application & Utilization Technique

Product Code : 40 x 40 - DSDL - 19 x 4 - SS



CODE	DESCRIPTION	SIZE	THICKNESS
9604	40.40.DSDL.19.4.S.S.1.2.4	4'	1.2mm/18swg
9605	40.40.DSDL.19.4.S.S.1.2.6	6'	1.2mm/18swg
9606	40.40.DSDL.19.4.S.S.1.2.8	8'	1.2mm/18swg
9607	40.40.DSDL.19.4.S.S.1.2.10	10'	1.2mm/18swg
9608	40.40.DSDL.19.4.S.S.1.5.4	4'	1.5mm/16swg
9609	40.40.DSDL.19.4.S.S.1.5.6	6'	1.5mm/16swg
9610	40.40.DSDL.19.4.S.S.1.5.8	8'	1.5mm/16swg
9611	40.40.DSDL.19.4.S.S.1.5.10	10'	1.5mm/16swg



Recta Pole Bracket

CODE	DESCRIPTION	THICKNESS
9612	PMB.S.S.	2.00MM



90° Pole Bracket

CODE	DESCRIPTION	SIZE	THICKNESS
9613	RPB.DSDL.19.4.S.S.1.2.6	6"	1.20mm
9614	RPB.DSDL.19.4.S.S.1.2.9	9"	1.20mm
9615	RPB.DSDL.19.4.S.S.1.2.12	12"	1.20mm
9616	RPB.DSDL.19.4.S.S.1.2.15	15"	1.20mm
9617	RPB.DSDL.19.4.S.S.1.2.18	18"	1.20mm



360° Pole Bracket

CODE	DESCRIPTION	SIZE	THICKNESS
9618	90PB.DSDL.19.4.S.S.2.6	6"	2.00mm
9619	90PB.DSDL.19.4.S.S.2.9	9"	2.00mm
9620	90PB.DSDL.19.4.S.S.2.12	12"	2.00mm
9621	90PB.DSDL.19.4.S.S.2.15	15"	2.00mm
9622	90PB.DSDL.19.4.S.S.2.18	18"	2.00mm



CODE	DESCRIPTION	SIZE	THICKNESS
9623	360PB.DSDL.19.4.S.S.2.6	6"	2.00mm
9624	360PB.DSDL.19.4.S.S.2.9	9"	2.00mm
9625	360PB.DSDL.19.4.S.S.2.12	12"	2.00mm
9626	360PB.DSDL.19.4.S.S.2.15	15"	2.00mm
9627	360PB.DSDL.19.4.S.S.2.18	18"	2.00mm

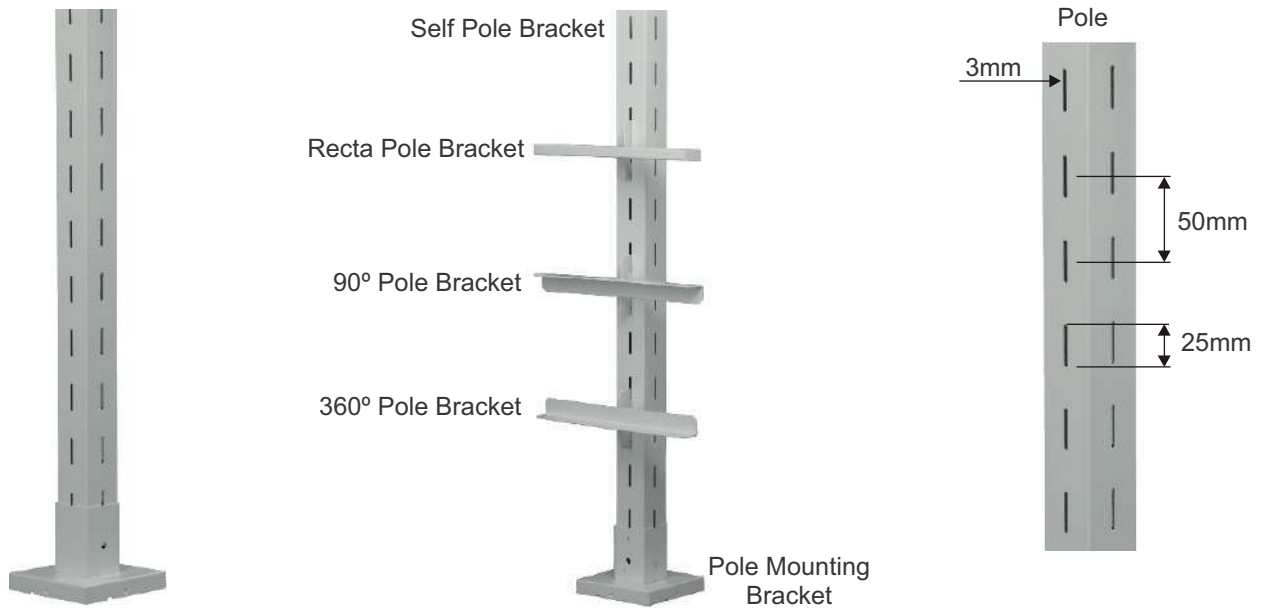

Application & Utilization Technique

Product Code : 40 x 40 - SSSL - 25 x 3 - PC

Pole



CODE	DESCRIPTION	SIZE	THICKNESS
9628	40.40.SSSL.25.3.P.C.1.2.4	4'	1.2mm/18swg
9629	40.40.SSSL.25.3.P.C.1.2.6	6'	1.2mm/18swg
9630	40.40.SSSL.25.3.P.C.1.2.8	8'	1.2mm/18swg
9631	40.40.SSSL.25.3.P.C.1.2.10	10'	1.2mm/18swg
9632	40.40.SSSL.25.3.P.C.1.5.4	4'	1.5mm/16swg
9633	40.40.SSSL.25.3.P.C.1.5.6	6'	1.5mm/16swg
9634	40.40.SSSL.25.3.P.C.1.5.8	8'	1.5mm/16swg
9635	40.40.SSSL.25.3.P.C.1.5.10	10'	1.5mm/16swg



CODE	DESCRIPTION	THICKNESS
9636	PMB.PC	2.00MM

Recta Pole Bracket



CODE	DESCRIPTION	SIZE	THICKNESS
9637	RPB.SSSL.25.3.P.C.1.2.6	6"	1.20mm
9638	RPB.SSSL.25.3.P.C.1.2.9	9"	1.20mm
9639	RPB.SSSL.25.3.P.C.1.2. 12	12"	1.20mm
9640	RPB.SSSL.25.3.P.C.1.2. 15	15"	1.20mm
9641	RPB.SSSL.25.3.P.C.1.2. 18	18"	1.20mm

90° Pole Bracket

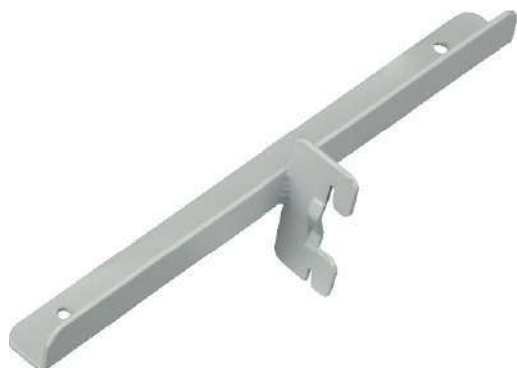

CODE	DESCRIPTION	SIZE	THICKNESS
9642	90PB.SSSL.25.3.P.C.2.6	6"	2.00mm
9643	90PB.SSSL.25.3.P.C.2.9	9"	2.00mm
9644	90PB.SSSL.25.3.P.C.2. 12	12"	2.00mm
9645	90PB.SSSL.25.3. P.C.2. 15	15"	2.00mm
9646	90PB.SSSL.25.3.P.C.2. 18	18"	2.00mm

360° Pole Bracket



CODE	DESCRIPTION	SIZE	THICKNESS
9647	360PB.SSSL.25.3.P.C.2.6	6"	2.00mm
9648	360PB.SSSL.25.3.P.C.2.9	9"	2.00mm
9649	360PB.SSSL.25.3.P.C.2.12	12"	2.00mm
9650	360PB.SSSL.25.3.P.C.2.15	15"	2.00mm
9651	360PB.SSSL.25.3.P.C.2.18	18"	2.00mm

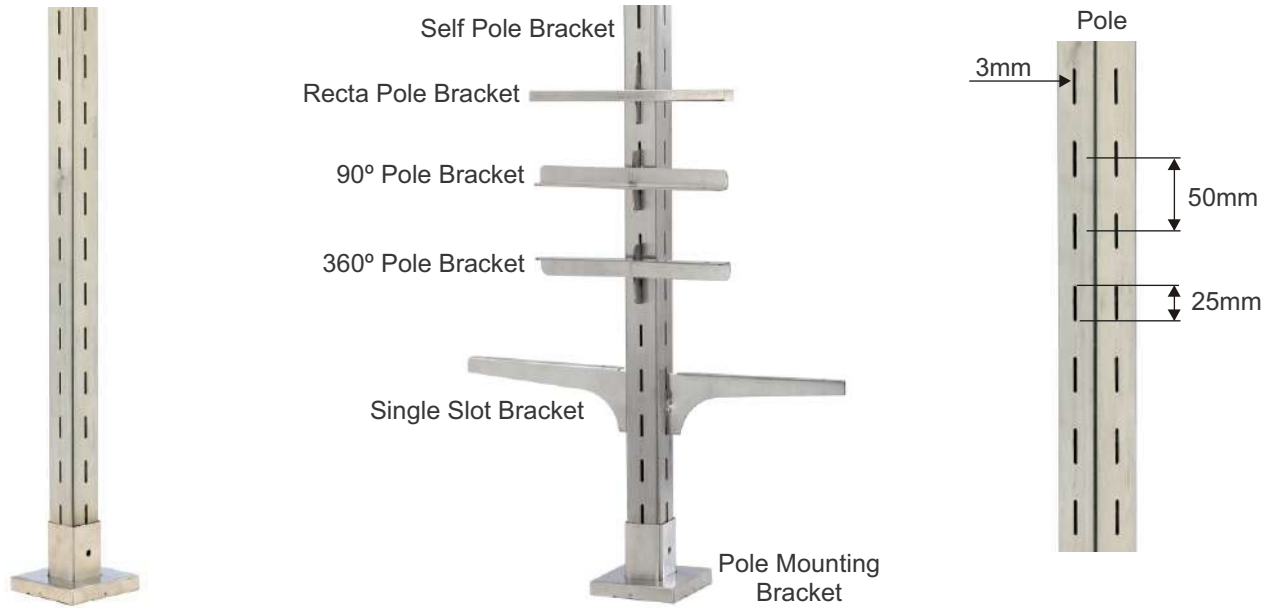

Application & Utilization Technique

Product Code : 40 x 40 - SSSL - 25 x 3 - SS



CODE	DESCRIPTION	SIZE	THICKNESS
9652	40.40.SSSL.25.3.S.S.1.2.4	4'	1.2mm/18swg
9653	40.40.SSSL.25.3.S.S.1.2.6	6'	1.2mm/18swg
9654	40.40.SSSL.25.3.S.S.1.2.8	8'	1.2mm/18swg
9655	40.40.SSSL.25.3.S.S.1.2.10	10'	1.2mm/18swg
9656	40.40.SSSL.25.3.S.S.1.5.4	4'	1.5mm/16swg
9657	40.40.SSSL.25.3.S.S.1.5.6	6'	1.5mm/16swg
9658	40.40.SSSL.25.3.S.S.1.5.8	8'	1.5mm/16swg
9659	40.40.SSSL.25.3.S.S.1.5.10	10'	1.5mm/16swg

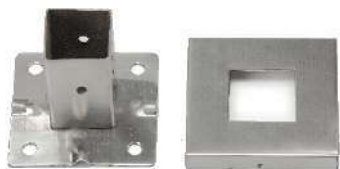

Recta Pole Bracket

CODE	DESCRIPTION	THICKNESS
9660	PMB.S.S.	2.00MM



90° Pole Bracket

CODE	DESCRIPTION	SIZE	THICKNESS
9661	RPB.SSSL.25.3.S.S.1.2.6	6"	1.20mm
9662	RPB.SSSL.25.3.S.S.1.2.9	9"	1.20mm
9663	RPB.SSSL.25.3.S.S.1.2. 12	12"	1.20mm
9664	RPB.SSSL.25.3.S.S.1.2. 15	15"	1.20mm
9665	RPB.SSSL.25.3.S.S.1.2. 18	18"	1.20mm



360° Pole Bracket

CODE	DESCRIPTION	SIZE	THICKNESS
9666	90PB.SSSL.25.3.S.S..2.6	6"	2.00mm
9667	90PB.SSSL.25.3.S.S.2.9	9"	2.00mm
9668	90PB.SSSL.25.3.S.S.2. 12	12"	2.00mm
9669	90PB.SSSL.25.3. S.S.2. 15	15"	2.00mm
9670	90PB.SSSL.25.3.S.S.2. 18	18"	2.00mm



CODE	DESCRIPTION	SIZE	THICKNESS
9671	36OPB.SSSL.25.3.S.S.2.6	6"	2.00mm
9672	36OPB.SSSL.25.3.S.S.2.9	9"	2.00mm
9673	36OPB.SSSL.25.3.S.S.2.12	12"	2.00mm
9674	36OPB.SSSL.25.3.S.S.2.15	15"	2.00mm
9675	36OPB.SSSL.25.3.S.S.2.18	18"	2.00mm

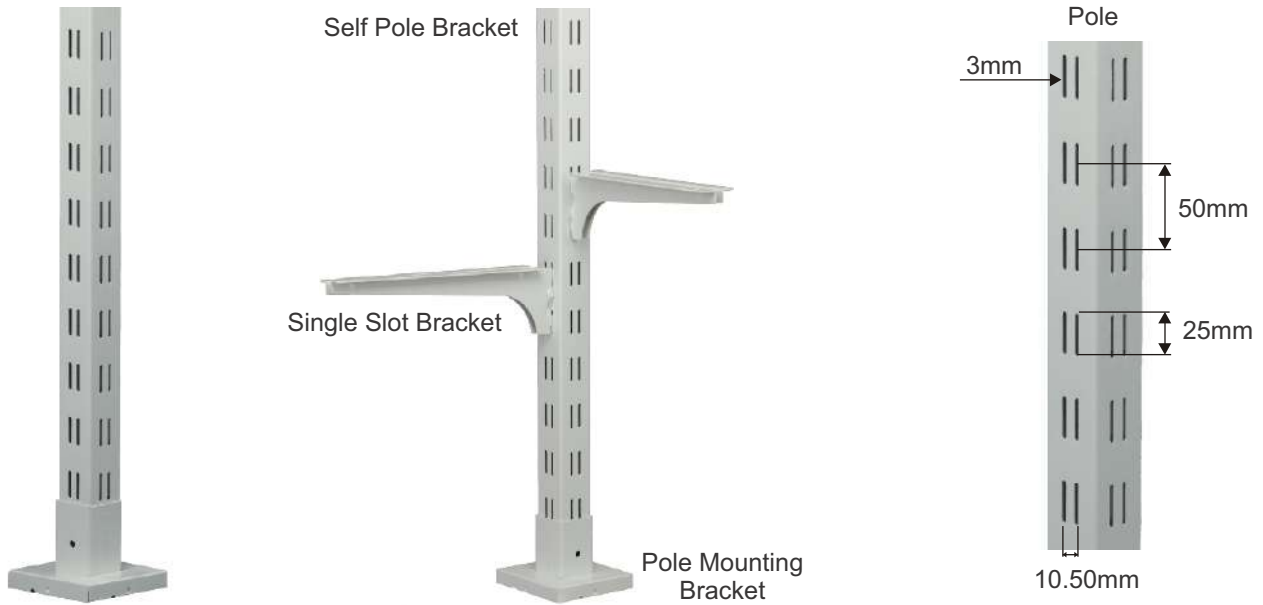

Application & Utilization Technique

Product Code : 40 x 40 - SSDL - 25 x 3 - PC



CODE	DESCRIPTION	SIZE	THICKNESS
9676	40.40.SSDL.25.3.P.C.1.2.4	4'	1.2mm/18swg
9677	40.40.SSDL.25.3.P.C.1.2.6	6'	1.2mm/18swg
9678	40.40.SSDL.25.3.P.C.1.2.8	8'	1.2mm/18swg
9679	40.40.SSDL.25.3.P.C.1.2.10	10'	1.2mm/18swg
9680	40.40.SSDL.25.3.P.C.1.5.4	4'	1.5mm/16swg
9681	40.40.SSDL.25.3.P.C.1.5.6	6'	1.5mm/16swg
9682	40.40.SSDL.25.3.P.C.1.5.8	8'	1.5mm/16swg
9683	40.40.SSDL.25.3.P.C.1.5.10	10'	1.5mm/16swg



CODE	DESCRIPTION	THICKNESS
9684	PMB.P.C.	2.00MM

Recta Pole Bracket

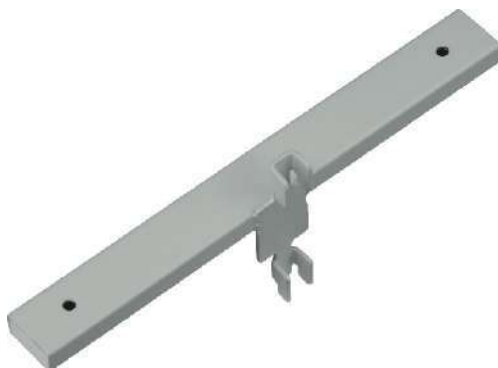

CODE	DESCRIPTION	SIZE	THICKNESS
9685	RPB.SSDL.25.3.P.C.1.2.6	6"	1.20mm
9686	RPB.SSDL.25.3.P.C.1.2.9	9"	1.20mm
9687	RPB.SSDL.25.3.P.C.1.2. 12	12"	1.20mm
9688	RPB.SSDL.25.3.P.C.1.2. 15	15"	1.20mm
9689	RPB.SSDL.25.3.P.C.1.2. 18	18"	1.20mm

90° Pole Bracket

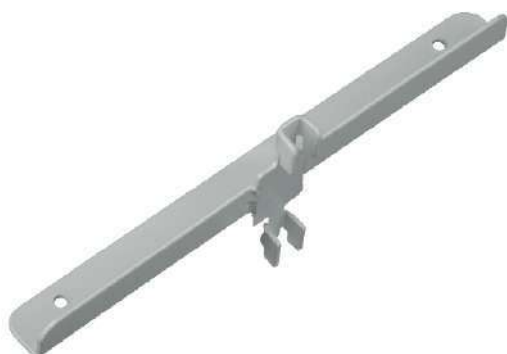

CODE	DESCRIPTION	SIZE	THICKNESS
9690	90PB.SSDL.25.3.P.C.2.6	6"	2.00mm
9691	90PB.SSDL.25.3.P.C.2.9	9"	2.00mm
9692	90PB.SSDL.25.3.P.C.2. 12	12"	2.00mm
9693	90PB.SSDL.25.3. P.C.2. 15	15"	2.00mm
9694	90PB.SSDL.25.3.P.C.2. 18	18"	2.00mm

360° Pole Bracket

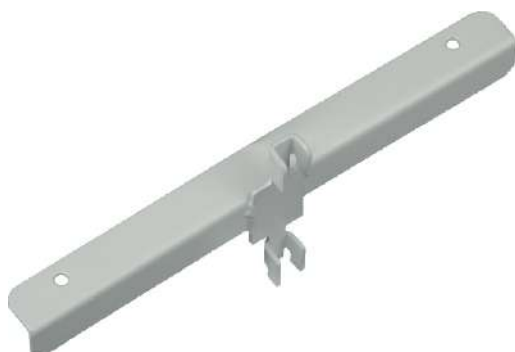

CODE	DESCRIPTION	SIZE	THICKNESS
9695	36OPB.SSSL.25.3.S.S.2.6	6"	2.00mm
9696	36OPB.SSSL.25.3.S.S.2.9	9"	2.00mm
9697	36OPB.SSSL.25.3.S.S.2.12	12"	2.00mm
9698	36OPB.SSSL.25.3.S.S.2.15	15"	2.00mm
9699	36OPB.SSSL.25.3.S.S.2.18	18"	2.00mm

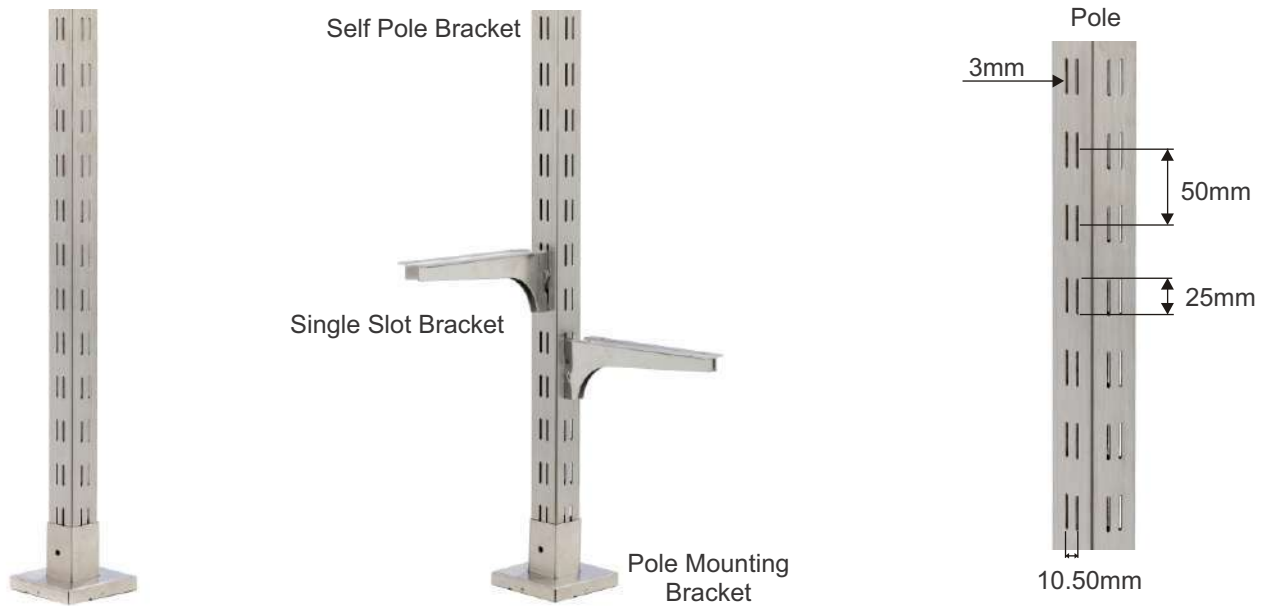

Application & Utilization Technique

Product Code : 40 x 40 - SSDL - 25 x 3 - SS



CODE	DESCRIPTION	SIZE	THICKNESS
9700	40.40.SSDL.25.3.S.S.1.2.4	4'	1.2mm/18swg
9701	40.40.SSDL.25.3.S.S.1.2.6	6'	1.2mm/18swg
9702	40.40.SSDL.25.3.S.S.1.2.8	8'	1.2mm/18swg
9703	40.40.SSDL.25.3.S.S.1.2.10	10'	1.2mm/18swg

9704	40.40.SSDL.25.3.S.S.1.5.4	4'	1.5mm/16swg
9705	40.40.SSDL.25.3.S.S.1.5.6	6'	1.5mm/16swg
9706	40.40.SSDL.25.3.S.S.1.5.8	8'	1.5mm/16swg
9707	40.40.SSDL.25.3.S.S.1.5.10	10'	1.5mm/16swg

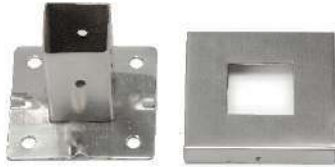

CODE	DESCRIPTION	THICKNESS
9708	PMB.S.S.	2.00MM

Recta Pole Bracket



CODE	DESCRIPTION	SIZE	THICKNESS
9709	RPB.SSDL.25.3.S.S.1.2.6	6"	1.20mm
9710	RPB.SSDL.25.3.S.S.1.2.9	9"	1.20mm
9711	RPB.SSDL.25.3.S.S.1.2. 12	12"	1.20mm
9712	RPB.SSDL.25.3.S.S.1.2. 15	15"	1.20mm
9713	RPB.SSDL.25.3.S.S.1.2. 18	18"	1.20mm

90° Pole Bracket



CODE	DESCRIPTION	SIZE	THICKNESS
9714	90PB.SSDL.25.3.S.S.2.6	6"	2.00mm
9715	90PB.SSDL.25.3.S.S.2.9	9"	2.00mm
9716	90PB.SSDL.25.3.S.S.2. 12	12"	2.00mm
9717	90PB.SSDL.25.3. S.S.2. 15	15"	2.00mm
9718	90PB.SSDL.25.3.S.S.2. 18	18"	2.00mm

360° Pole Bracket



CODE	DESCRIPTION	SIZE	THICKNESS
9719	360PB.SSSL.25.3.S.S.2.6	6"	2.00mm
9720	360PB.SSSL.25.3.S.S.2.9	9"	2.00mm
9721	360PB.SSSL.25.3.S.S.2.12	12"	2.00mm
9722	360PB.SSSL.25.3.S.S.2.15	15"	2.00mm
9723	360PB.SSSL.25.3.S.S.2.18	18"	2.00mm

(ALLUMINIUM)

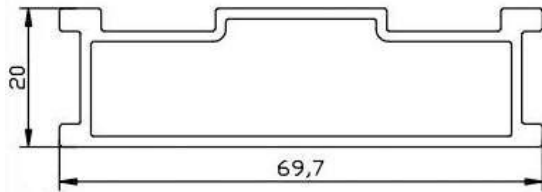

Code : 9724
 Size : 12 feet
 Finish : Alluminium
 Weight : 3kg
 Packing : 10pc.

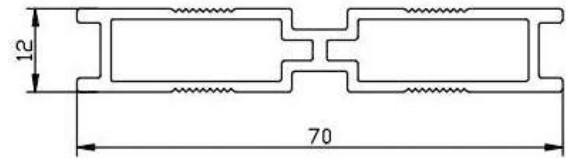

Code : 9725
 Size : 12 feet
 Finish : Alluminium
 Weight : 2.5kg
 Packing : 10pc.

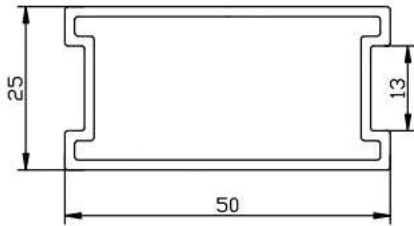

Code : 9726
 Size : 12 feet
 Finish : Alluminium
 Weight : 2.3kg
 Packing : 10pc.

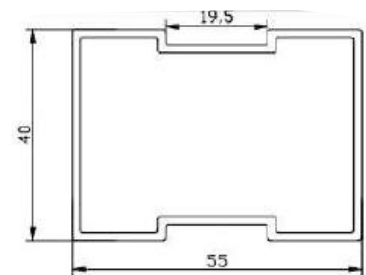

Code : 9727
 Size : 12 feet
 Finish : Alluminium
 Weight : 2.9kg
 Packing : 10pc.

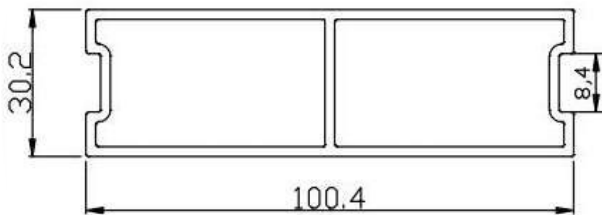

Code : 9728
 Size : 12 feet
 Finish : Alluminium
 Weight : 5.71kg
 Packing : 10pc.

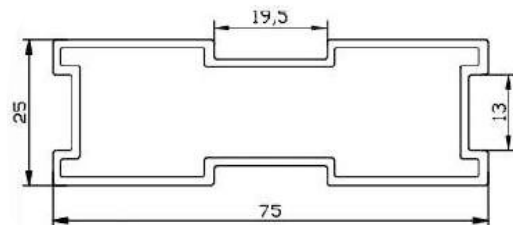

Code : 9729
 Size : 12 feet
 Finish : Alluminium
 Weight : 3.2kg
 Packing : 10pc.

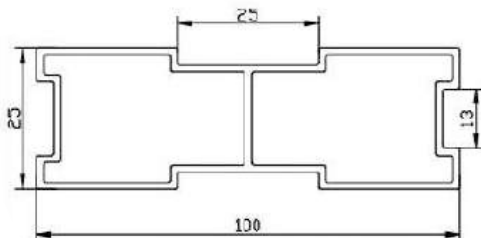

Code : 9730
 Size : 12 feet
 Finish : Alluminium
 Weight : 3.5kg
 Packing : 10pc.

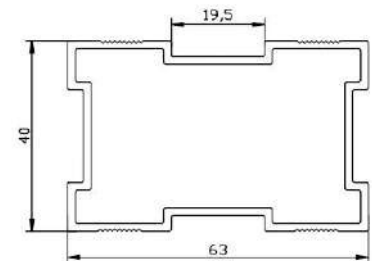

Code : 9731
 Size : 12 feet
 Finish : Alluminium
 Weight : 3.5kg
 Packing : 10pc.

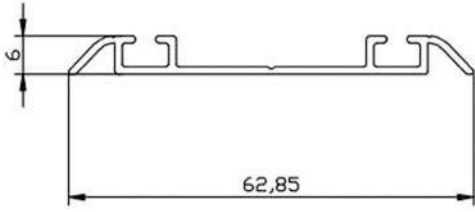

Code : 9732
 Size : 8feet / 12 feet
 Finish : Alluminium
 Packing : 10pc.

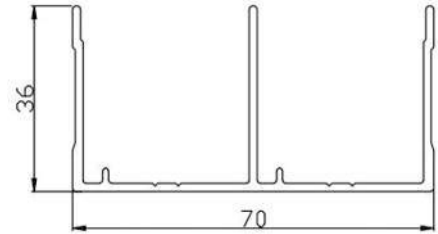

Code : 9733
 Size : 8feet / 12 feet
 Finish : Alluminium
 Packing : 10pc.

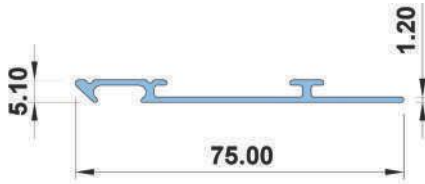

Code : 9734
 Size : 10 feet
 Finish : Alluminium
 Weight Per ft : 0.110gms
 Packing : 10pc.

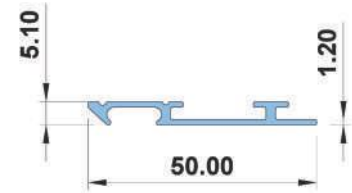

Code : 9735
 Size : 10 feet
 Finish : Alluminium
 Weight Per ft : 0.080gms
 Packing : 10pc.

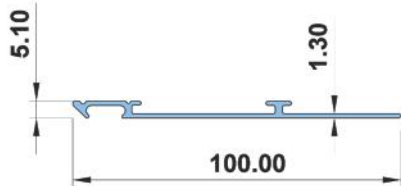

Code : 9736
 Size : 10 feet
 Finish : Alluminium
 Weight Per ft : 0.140gms
 Packing : 10pc.

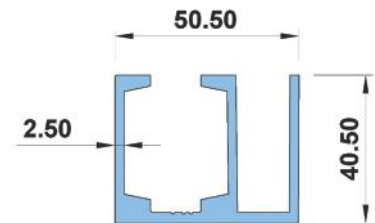

Code : 9737
 Size : 8 feet, 10 feet, 12 feet
 Finish : Alluminium
 Weight Per ft : 0.460gms
 Packing : 10pc.

GLAZING PROFILE

ALLUMINIUM

Code : 9738
 Size : 10 feet, 12 feet
 Finish : Alluminium
 Weight Per ft : 0.270gms
 Packing : 10pc.



ANODIZED

Code : 9739
 Size : 10 feet, 12 feet
 Finish : Anodize
 Weight Per ft : 0.320gms
 Packing : 10pc.

